

Chemistry and Biochemistry

Theory of laboratory exercises

1st year, Dentistry

WINTER SEMESTER



Department of Medical Chemistry and Biochemistry

Faculty of Medicine in Pilsen

Charles University

SUMMARY

<u>Basic skills for laboratory work</u>	page 3
- Measurement of volumes	
- Weighing	
- Centrifugation	
- Filtration	
<u>Osmosis, osmotic pressure, osmolality</u>	page 10
- Determination of osmolality on the principle of cryoscopic effect	
<u>Chromatography</u>	page 13
- Basic classification of chromatographic methods	
- A) according to chromatographic bed shape	
- B) according to the state of matter of the phases	
- C) according to the physico-chemical principle of separation	
- Evaluation of chromatographic method	
<u>Acid-base equilibria, pH</u>	page 20
- Hydrogen exponent (pH)	
- Calculation of pH of solutions of strong acids and hydroxides	
- Calculation of pH of weak acid and hydroxide solutions	
<u>pH measurement</u>	page 23
- Colorimetric pH measurement	
- Potentiometry	
- Potentiometric pH measurement	
<u>Buffers</u>	page 31
- Henderson-Hasselbalch equation	
- Function of buffers	
<u>Volumetric analysis</u>	page 34
- Acid-base titration / Neutralization titration	
- Complexometric titration	
<u>Optical methods</u>	page 41
- Properties of electromagnetic radiation	
- Absorption and emission of radiation, colourfulness of substances	
- Reflection of light and its refraction	
- Light interference	
- Diffraction	
- Photoelectric effect	
- Absorption spectrophotometry	
- Determination of the concentration	
- Flame photometry	
<u>Enzymology</u>	page 56
- Introduction to enzymology	
- Enzyme kinetics	
- Inhibition and regulation of enzyme activity	
- Catalase and reactive oxygen species	

Basic skills for laboratory work

Measurement of volumes

Volumetric glass is used to measure volumes of liquids in laboratories. There is a volume marking on each volumetric glass. There are 2 types of volumetric glass calibration - “to contain” (marked D / In) and “to deliver” (marked V / Ex). Considering liquids exhibit thermal expansion, the temperature for which the calibration is performed is indicated on the graduated glass.

When reading the volume it is necessary to take into account the fact that the liquid, depending on its surface tension, wets the walls of the tube, the level is not flat, but creates a so-called meniscus. The volume is measured as the lower edge of the meniscus touches the line (Fig. 1). We use measuring cylinders for measuring larger volumes, such as tens or hundreds of milliliters. Pipettes are more suitable for measuring smaller volumes. Automatic pipettes are used for very accurate measurement of the smallest volumes (microliters).

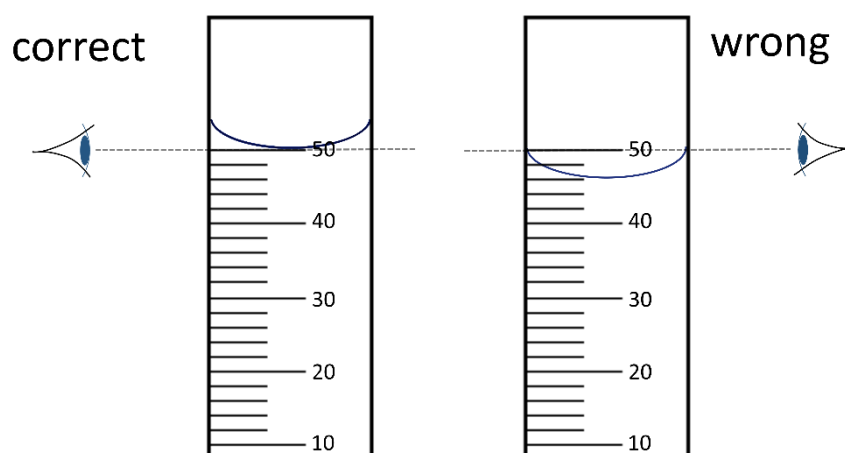

Correct reading of liquid volume

Volumetric flask is a typical example of a volumetric glass calibrated “to contain”. Volumetric flasks are used in the preparation of solutions. It is a flask with a long, narrow neck with a mark of appropriate volume.

Pipettes are a typical representative of glass calibrated “to deliver”. They are tubes used to measure and transfer liquids. Glass pipettes are available in different sizes. There are two types: non-divided, to measure a single volume (eg to a volume of 1, 2, 5, 10 or 25 ml) or divided (the scale is divided into smaller units). The size and graduation of the pipette is indicated on the pipette. E.g. 2 IN 1/50 ml means: total pipette volume is 2 ml, 1 segment = 1/50 ml. The temperature at which the volume should be measured (eg 20 ° C) is also given.

Formerly, harmless solutions were sucked into a pipette by mouth. Today it is forbidden for safety reasons. Special pipette attachments or safety bulb pipette filler are used. The solution is soaked up 2 - 3 cm above the line, and then it is carefully dropped to the required volume.

Pipetting with safety bulb pipette filler:

Press the "A" (air) to evacuate air out of the bulb. Gently but firmly place the safety bulb pipette filler to the upper end of the pipette. Then put the pipette into the solution and press the "S" (suction) to intake the solution. Draw the solution up until it is well above the mark. Try not to draw the solution into the bulb (keep the pipet tip in liquid when drawing it up to avoid production of bubbles). Press the "E" (empty) valve to adjust the liquid level so meniscus matches the line. Finally the pipette is transferred to the container, where we need the solution. The pipette is emptied by pressing "E" (empty). There will be a very small amount of the solution left in the pipette. Do not force this solution out! (*This is due to the pipettes are calibrated "to deliver". The solution is to be adhered to the walls or retained by capillary forces.*)

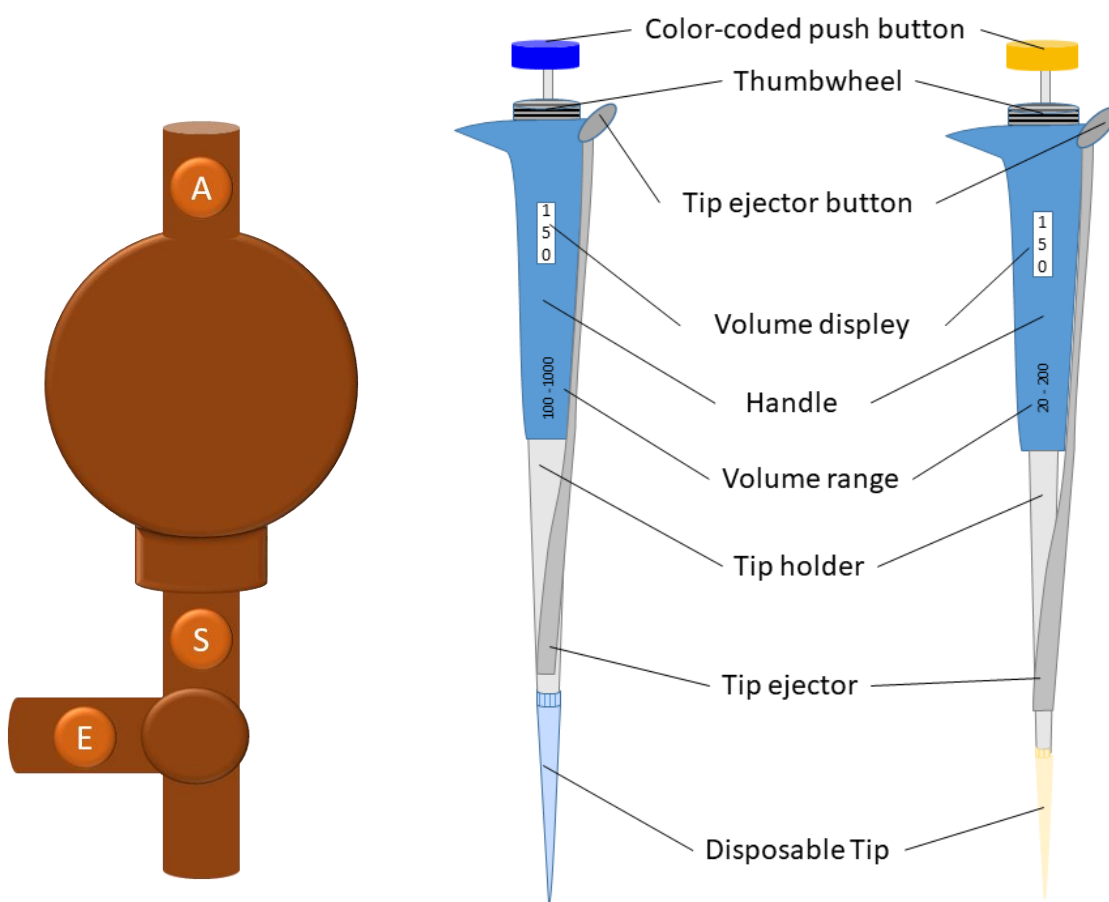

Safety bulb pipette filler.

Scheme of automatic pipette

For very small volumes, mechanical pipettes (often referred to as "automatic pipettes") are used. Fixed-volume (single-volume) or adjustable-volume pipettes (range indicated on the pipette) are produced. It is necessary to place an appropriate tip on the pipette before usage. A push button is operated by the thumb. The volume on the pipette is given in microliters (e. g. 100, 200, 500, 1000, etc.). The tips are made of chemically and mechanically resistant non-wettable plastic in four basic volume types - white (0.2 - 10 μl), yellow (10 - 250 μl), blue (200 - 1000 μl) and large white (5000 μl and 10 000 μl). The tip colour usually corresponds to the colour on the push button.

Working with the automatic pipette:

- Depending on the required volume of the pipetting solution, select the appropriate pipette: a fixed volume pipette or an adjustable pipette with the appropriate range (indicated on the pipette).
- For the adjustable pipette, set the required volume on the scale by turning the wheel:

The range on the plunger:	2 / 20	<table border="1"><tr><td>0</td></tr></table>	0		<table border="1"><tr><td>1</td></tr></table>	1		<table border="1"><tr><td>2</td></tr></table>	2	
0										
1										
2										
The minimum volume:	2 μ l	<table border="1"><tr><td>2</td></tr></table>	2	2 μ l	<table border="1"><tr><td>5</td></tr></table>	5	15 μ l	<table border="1"><tr><td>0</td></tr></table>	0	20 μ l
2										
5										
0										
The maximum volume:	20 μ l	<table border="1"><tr><td>0</td></tr></table>	0		<table border="1"><tr><td>0</td></tr></table>	0		<table border="1"><tr><td>0</td></tr></table>	0	
0										
0										
0										

The range on the plunger:	20 / 200	<table border="1"><tr><td>0</td></tr></table>	0		<table border="1"><tr><td>1</td></tr></table>	1		<table border="1"><tr><td>2</td></tr></table>	2	
0										
1										
2										
The minimum volume:	20 μ l	<table border="1"><tr><td>2</td></tr></table>	2	20 μ l	<table border="1"><tr><td>5</td></tr></table>	5	150 μ l	<table border="1"><tr><td>0</td></tr></table>	0	200 μ l
2										
5										
0										
The maximum volume:	200 μ l	<table border="1"><tr><td>0</td></tr></table>	0		<table border="1"><tr><td>0</td></tr></table>	0		<table border="1"><tr><td>0</td></tr></table>	0	
0										
0										
0										

The range on the plunger:	200 / 1000	<table border="1"><tr><td>0</td></tr></table>	0		<table border="1"><tr><td>0</td></tr></table>	0		<table border="1"><tr><td>1</td></tr></table>	1	
0										
0										
1										
The minimum volume:	200 μ l	<table border="1"><tr><td>2</td></tr></table>	2	200 μ l	<table border="1"><tr><td>5</td></tr></table>	5	550 μ l	<table border="1"><tr><td>0</td></tr></table>	0	1000 μ l
2										
5										
0										
The maximum volume:	1000 μ l	<table border="1"><tr><td>0</td></tr></table>	0		<table border="1"><tr><td>5</td></tr></table>	5		<table border="1"><tr><td>0</td></tr></table>	0	
0										
5										
0										

- When pipetting, press the push button to the first stop, immerse the pipette in the solution, and slowly let up the push button to draw the solution to the tip. The solution is pipetted to the bottom of the container, the tip not being submerged in the solution.
- The pipette must be held in an upright position with the tip down for the entire duration of handling!
- After transfer to the appropriate container, remove the tip by pressing the ejector button or push button to the third position. Place the pipette vertically in the rack. Always use a new tip to pipet a new solution.

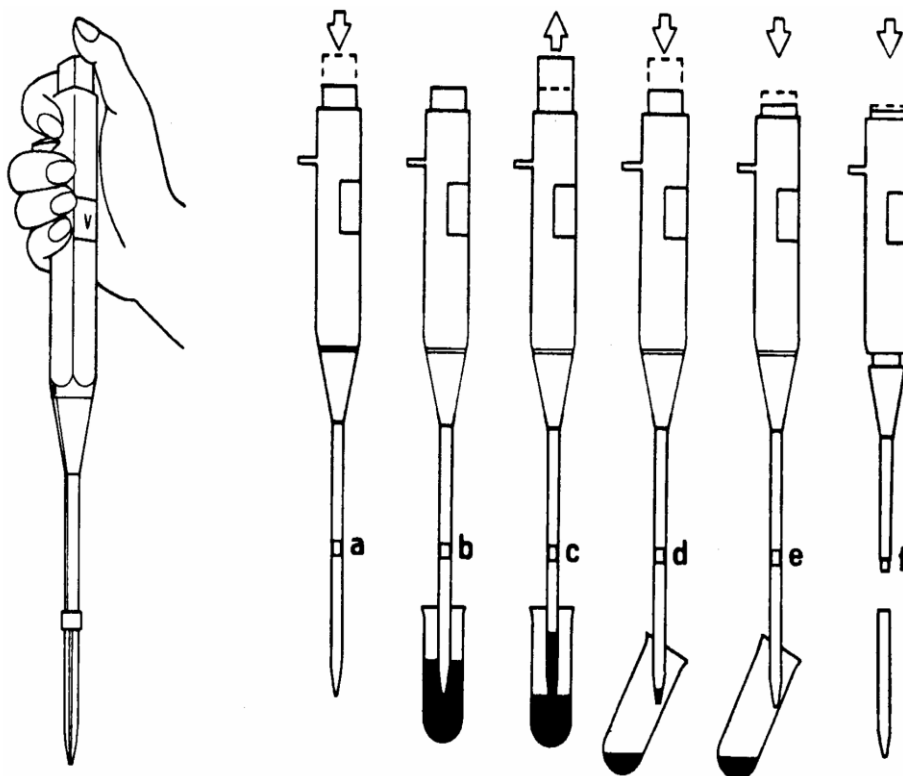

Working with mechanical dosing pipette

Weighing

Never pour the weighed substance directly onto the weighing pan!!! It is always necessary to use a suitable container (weighing bottle, beaker, watch glass...) or a square of paper with a smooth surface, cellophane or aluminium foil. If the weighing substance is spilled, the scales must be cleaned immediately.

You will be working with digital scales that allow you to set zero weight called taring. Place the weighing bottle on the weighing surface and press the "TARE" button. This recalibrates the zero weight and can be weighed without having to weigh the weighing bottle.

Weighing capacity = maximum weight that can be weighed on scales

Sensitivity = accuracy of the balance

Centrifugation

Centrifugation is a separation method separating components from a suspension based on different densities by centrifugal force. The centrifugation force accelerates the sedimentation of the individual components. In the biochemical laboratory, it is used, for example, to remove blood cells in the preparation of plasma or serum, to remove a precipitate from solution, or to concentrate particles from body fluids for microscopic determination.

The centrifugation conditions are expressed in two ways:

1. relative centrifugal force (= RCF), which indicates how many times the centrifugal acceleration is greater than the Earth's gravitational acceleration g
2. using revolutions per minute (= RPM)

and the duration of centrifugation.

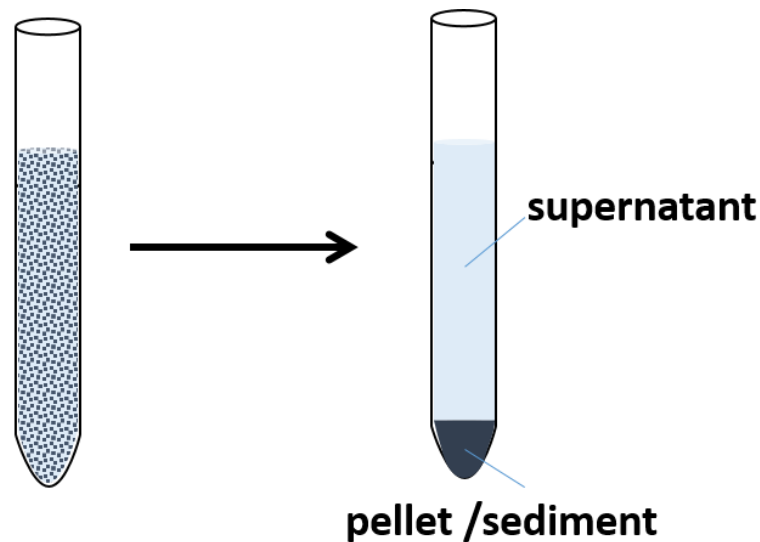

Result of centrifugation

Filtration

Filtration is a separation method that allows separation of a solid from a liquid or gas. It uses filter screens made of different materials - filter papers with different pore sizes, porous glass or porcelain fritted filter (special filter equipment), glass wool, textile filters, sand filters, etc. The filtered mixture is poured onto the filter. Particles that are smaller than the pores pass through the filter and get into the filtrate, while the larger particles remain on the filter surface and form a so-called filter cake. The filter material is determined by the chemical nature of the filtered solution. The filtration rate depends on the area and properties of the filter medium, the number and size of the pores, the pressure and temperature during filtration, the nature of the precipitate and the viscosity of the filtered liquid.

The most common material for laboratory filtration is filter paper. It is made of cellulose fibers. Filters with different pore sizes can be prepared according to the fiber choice. Soft filter paper has the largest pores, while hard filter paper has the smallest pores. Most commonly, medium-density, medium-pore size filter is used. This filters can trap most precipitates and debris. Filter paper is not suitable for filtering strongly acidic or alkaline substances or strong oxidizing agents. It is suitable to use a porous glass or porcelain frit to filter these materials.

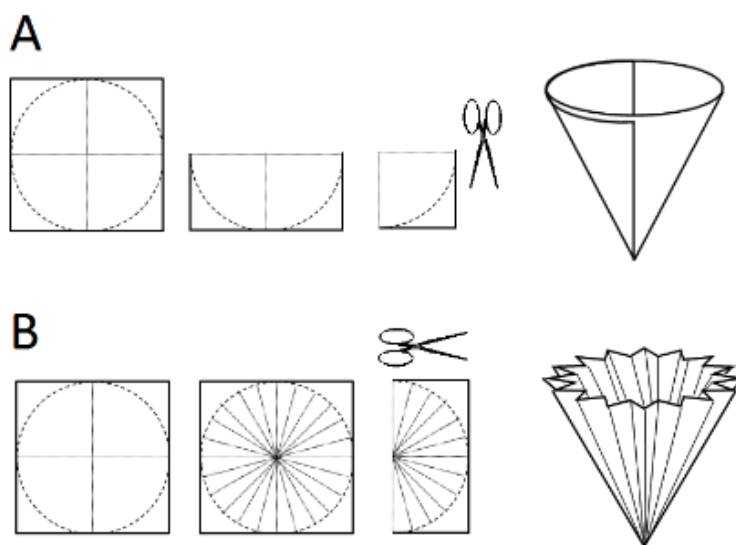

Preparation of smooth filter (A) and pleated filter (B).

Depending on the filtration pressure, the processes are divided into atmospheric pressure filtration, vacuum and positive pressure filtration. The simplest type is simple filtration at atmospheric pressure. The basic aid for this type of filtration is a filter funnel into which a suitably folded paper filter is inserted. In some simple cases, a wad of cotton can be used as a filter. Cotton wool filtration is suitable for volatile substances that would evaporate over a large area of the common filter.

The long-stem filter funnel (smooth or ribbed) is placed in the filter circle so that the stem touches the wall of the filtrate collection container. The filter size must be adapted to the size of the funnel - the filter should be approximately 0.5 cm below the funnel edge. Two types of paper filter are used - plain or pleated. Their preparation is shown in figure.

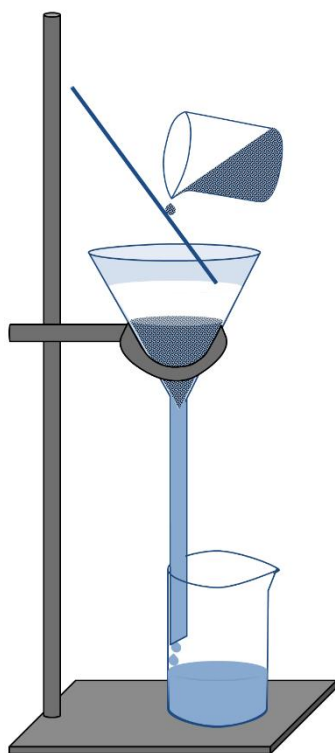

Atmospheric pressure filtration scheme.

The smooth filter is made from a square of filter paper, which is folded in half and further in a quarter. The free corners are cut off with scissors. One layer of folded paper is pulled away from the others to form a cone filter. It is moistened prior to being placed in the funnel so that the filter adheres well to its walls, thereby speeding up filtration by capillary forces between the paper surface and the funnel glass. However, never wet the filter when filtering organic water-immiscible solutions or when filtering for analytical purposes. During filtration, pour the filtered mixture carefully onto the filter over the glass stick (see in figure) to avoid damaging the filter. In no case do we touch it with the stick, because the moist filter paper is very little mechanically resistant and there is a risk of tearing it. The liquid stream should be directed against the location where the paper sheet is triple. The filter always fills a few millimeters below the edge.

Osmosis, osmotic pressure, osmolality

If there are two different concentrated solutions separated by a solvent-permeable membrane, the solvent passes from a site of lower concentration to a site of higher concentration. Solvent will pass until there are concentrations in balance. This phenomenon is called osmosis. In biological systems, there is osmosis essential in the transport of water between the cell and extracellular fluid.

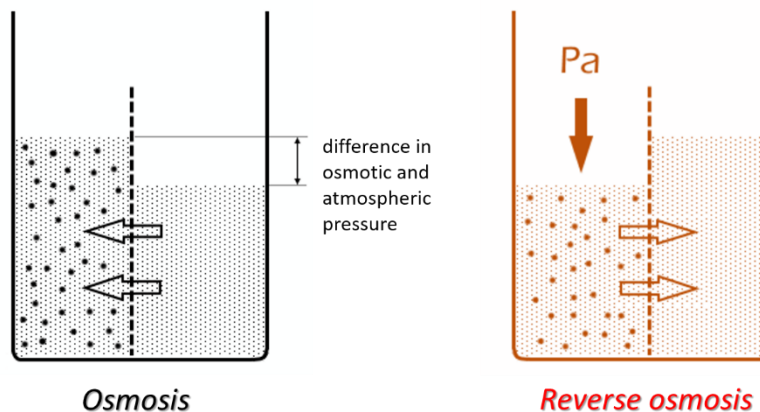

Osmosis can be quantified by the pressure that must be put on a more concentrated solution to inhibit osmosis, or by the negative pressure put on the site of lower concentration. The mechanism of osmotic pressure is not yet clear. However, an osmotic pressure is not invoked directly by the solute, but by a decrease of solvent activity due to the solutes.

Value of an osmotic pressure depends on the number of particles dissolved in a solution, but not on their type, size or charge. The term **osmolality** is used to express osmotic circumstances in a solution. Osmolality expresses the total **amount of all osmotically active particles** present in kilogram of solvent (mol / kg, formerly Osmol / kg). An osmolality of 1 mol / kg corresponds to an osmotic pressure of 2.7 MPa.

Solution of 1 mol of a substance in 1 kg of water forms a solution with osmolality:

glucose	1 mol/kg
NaCl (at 100% dissociation)	2 mol/kg
NaCl (at 86% dissociation in blood plasma)	1.86 mol/kg
AgCl (insoluble in water)	0 mol/kg

The term **tonicity** generally expresses differences in osmotic pressure at the interface. In human physiology, it refers to the "standard", which is blood plasma. A solution having the same osmotic pressure as plasma is called **isotonic**. A solution with lower osmotic pressure as plasma is called **hypotonic**. A solution with osmotic pressure higher than plasma is called **hypertonic**.

Osmotic ratios in plasma and urine belong to important diagnostic indicators. The physiological osmolality of plasma is about 285 ± 10 mmol / kg of water, which corresponds

to an osmotic pressure of 0.78 MPa. The osmotic pressure generated by plasma proteins is called **oncotic pressure**. It is about 0.3% of the total osmotic pressure. Urine osmolality is in a wider range (50 - 1400 mmol / kg water).

Reverse osmosis is used in water treatment technology. In this process, there is a pressure applied to a site of higher concentration and only the solvent (in this case, 'pure' water) passes through the semipermeable membrane. In fact, it is the opposite of simple osmosis. The reverse osmosis can replace distillation and it is possible to obtain deionized water.

The osmotically active substances in solution change the so-called colligative properties (properties dependent only on the number of particles) in comparison with the properties of pure solvent, they are reducing the vapour pressure above a solution, increasing of the boiling point of a solution (ebulioscopic effect), and lowering of the freezing point (cryoscopic effect).

Determination of osmolality on the principle of cryoscopic effect

At present, the most of osmometers are based on measurement of cryoscopic effect. Its name comes from the ancient Greek word *krýos*, meaning “ice, frost, cold, chilliness” and *skopeo*, which means “inspect, consider, examine”. The cryoscopic effect was described by the French physical chemist **François-Marie Raoult** (1830–1901), who studied multicomponent systems. According to Rault's Third Law, there is a decrease of solution freezing point in dependence on concentration of a solute. An osmometer (cryoscope) is, in principle, a very sensitive thermometer (1 mmol / kg corresponds to 0.001858 °C).

The osmometer measuring chamber is filled in by a solvent (distilled water). It is rapidly cooled to a temperature below solvents expected freezing point due to Peltier cell. Then, by external intervention, an immediate freezing of a solvent in its total volume is induced. As soon as the solvent begins to solidify, the monitored temperature rises to its freezing point (the latent heat of solidification) before cooling of the frozen solvent continues. The same process is repeated for a sample. The difference between freezing point of a sample and of a solvent is proportional to osmolality. It is a colligative property depending on the number of particles, not on identity of the particles.

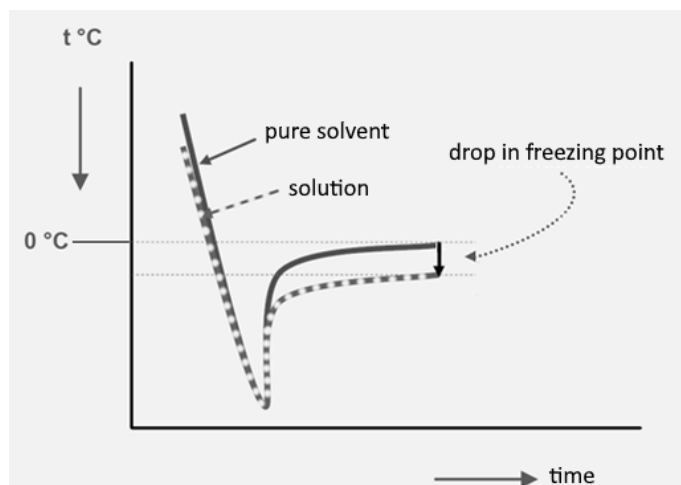

Graphical representation of temperature changes during cryoscopy

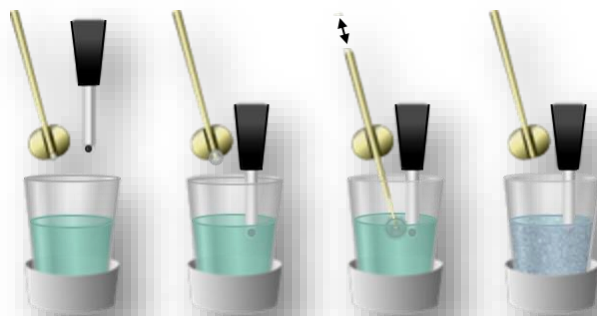

Initiation of specimen freezing, with a drop of ice on the needle

Chromatography

Chromatography is a separation method in which the components of a mixture are distributed between a **stationary** and a **mobile phase**. The stationary phase may be a solid or immobilised liquid, the mobile phase a liquid or gas. The components of the mixture that have a higher affinity for the stationary phase lag behind the more mobile components with a higher affinity for the mobile phase in the mobile phase stream, thereby separating them. The substance is divided between the two phases in terms of its **distribution constant** (K_D), which indicates the ratio of the concentrations of the substance present in the stationary phase ($[A]_s$) and in the mobile phase ($[A]_m$).

$K_D = \frac{[A]_s}{[A]_m}$ A component whose distribution constant is large will occur predominantly in the stationary phase and will move slower than a substance whose constant is small and which occurs predominantly in the mobile phase.

Chromatography can be used both to identify substances in a separated mixture (qualitative chromatographic analysis) or to determine the amount of individual components (quantitative chromatographic analysis) and to obtain a pure component of the mixture (preparative chromatography).

*The first chromatography was performed in 1906 by **Mikhail Semyonovich Tsvet** (Russian*



Muxauл Семёнович Цвем; 1872-1919; Russian botanist, physiologist and biochemist), in order to separate the pigments found in the leaves of plants. On the calcium carbonate column, he obtained two green bands (leaf pigment chlorophyll a and chlorophyll b) and several yellow bands (carotenoids). It was not until ten years later that Tsvet's discovery was recognized as a great technical contribution to this method of separation. The name of the chromatography was derived from the Greek "chroma" = "colour".

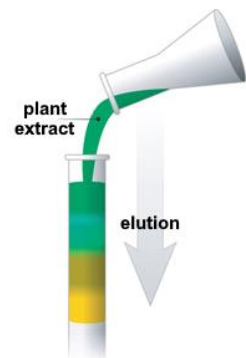

Basic classification of chromatographic methods

A) according to chromatographic bed shape:

- **column chromatography**

The base is a column, formed by a tube, fitted with a frit and a tap at the bottom (see picture). The tube is filled with chromatographically active material to form a column. The column must not dry out, otherwise cracks will appear in it and it will not function well. Anchoring the stationary phase to the support is referred to as impregnation. This is followed by sample application and elution. The flow rate of the mobile phase is usually given in mL / min. The mobile phase leaving the column is called the eluate. The separation can be accelerated by increasing the pressure on the mobile phase level.

A special type of column chromatography is high performance liquid chromatography (HPLC). The basis is a pump with high mobile phase pressure, a highly efficient column and a detector. The pump pushes the mobile phase under a pressure of up to 30 MPa into the column, where the sample is divided and the individual parts then gradually flow through the detector. The detector measures both the concentration of the flowing substance and the time elapsed since the start. The individual components are shown as peaks, their concentration is shown as the area under the peak.

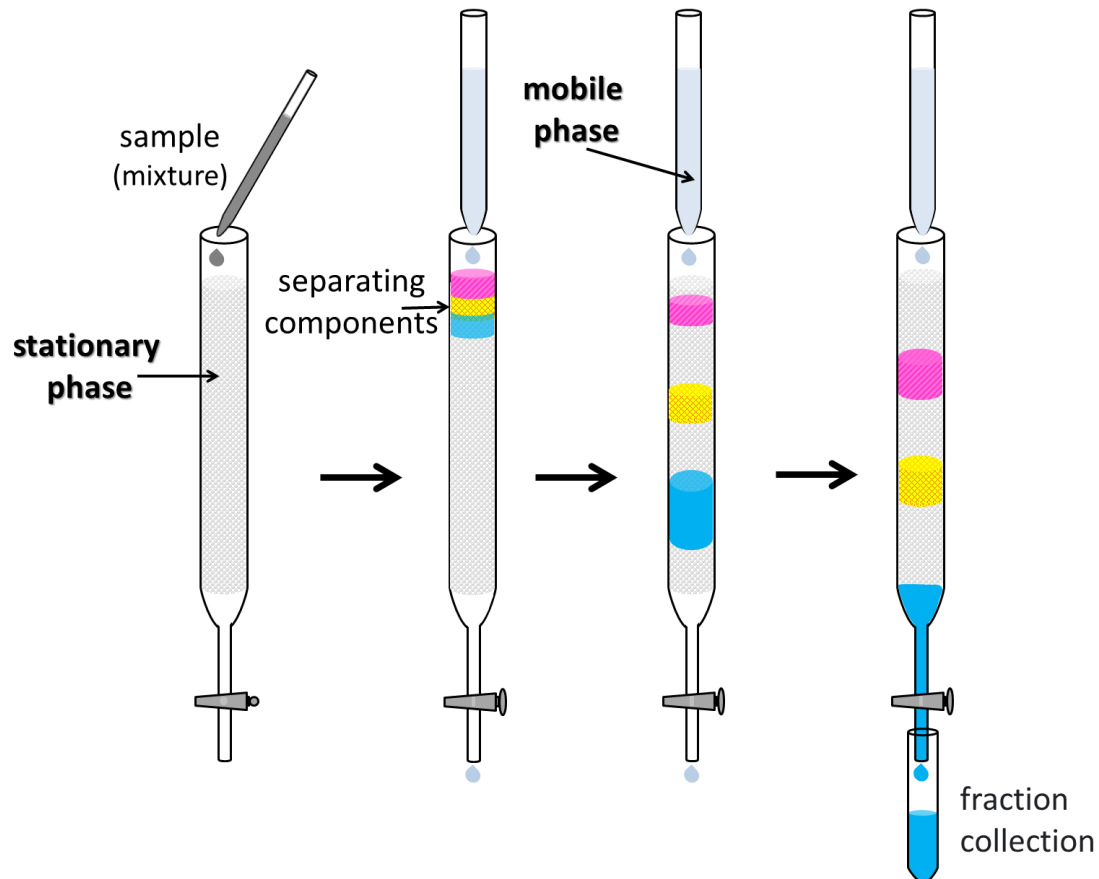

Column chromatography - the separation of a mixture of three substances on a chromatographic column.

- **planar chromatography**

The stationary phase is a sheet of chromatographic paper (paper chromatography) or a thin layer of adsorbent applied to a solid support (thin layer chromatography). The movement of the mobile phase is most often caused by its uplift.

According to the direction of movement of the mobile phase (solvent), exist these types of paper chromatography:

- ascending** (the solvent moves from bottom to top, see in picture)
- descending** (the solvent moves from top to bottom)
- radial** (the solvent extends radially from the centre of the paper)
- two-dimensional** (the separation is performed first in one direction and then with another different solvent in the perpendicular direction)

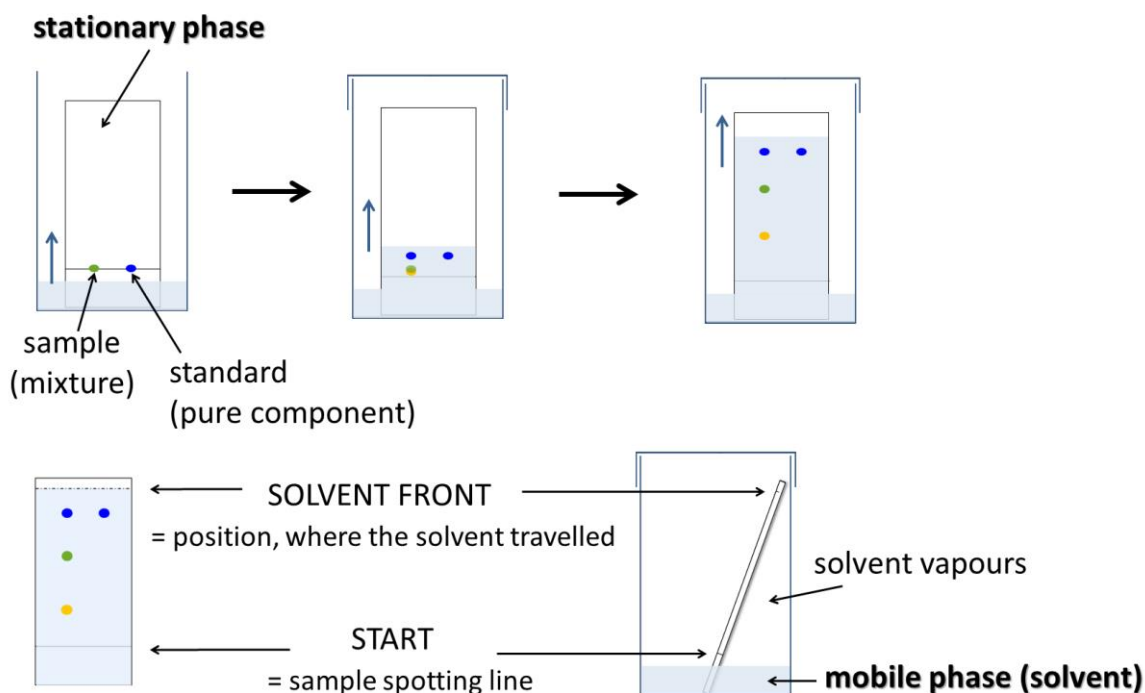

Planar chromatography – the course of separation of a mixture of three substances in a chromatographic chamber.

B) according to the state of matter of the phases:

- ***gas chromatography***

The separation can take place in a gas-liquid or gas-solid system. In the first case it is partition chromatography, in the second it is adsorption chromatography.

- ***liquid chromatography***

The separation of the mixture can take place in a liquid-liquid system (partition chromatography) or in a liquid-solid system (adsorption, gel or ion exchange chromatography).

C) according to the physico-chemical principle of separation:

- ***partition chromatography***

The stationary phase is a liquid (anchored on a suitable support) immiscible (which does not mix) with the liquid of the mobile phase. Separation occurs when substances have different distribution constants. The condition for successful separation is a higher solubility of the substance in the stationary phase than in the mobile phase.

- ***adsorption chromatography***

The stationary phase is a solid with adsorption properties (sorbent), the mobile phase is a liquid or gas. A sorbent is a substance that has a large surface on which it contains groups that form weak bonds with the separated substances. These weak bonds retain molecules of substances that are dissolved in the mobile phase. The mixtures are separated on the basis of the different adsorption affinity of the individual components for the stationary phase. The most common sorbents used in chromatography are silica gel, alumina and kieselguhr.

- **ion exchange chromatography**

The stationary phase is a substance with specific properties (ion exchanger), the mobile phase is a liquid. An ion exchanger is a polymeric substance that contains on its surface groups capable of dissociating in solution. Substances of an ionic nature are divided between stationary and mobile phases by the action of electrostatic forces between ions dissolved in the mobile phase and dissociated functional groups of the ion exchanger (e.g. $\sim\text{COO}^-$, $\sim\text{SO}_3^-$, $\sim\text{NH}_3^+$, $\sim\text{CH}_2\text{N}^+(\text{CH}_3)_3$). Ion exchangers can be divided according to charge into cation and anion exchangers. Cation exchanger contains negatively charged groups and divides cations. An anion exchanger, on the other hand, contains positively charged groups and divides anions (see figure). Ion exchanger can be regenerated using solutions containing the original ions. Acids, bases or even NaCl can be used as regeneration solutions, depending on the specific application and ion exchange polymer. The method is widely used, for example, for the preparation of deionized water, for the identification of isoenzymes, for the separation of proteins and for the removal of unwanted ions from a sample before its analysis.

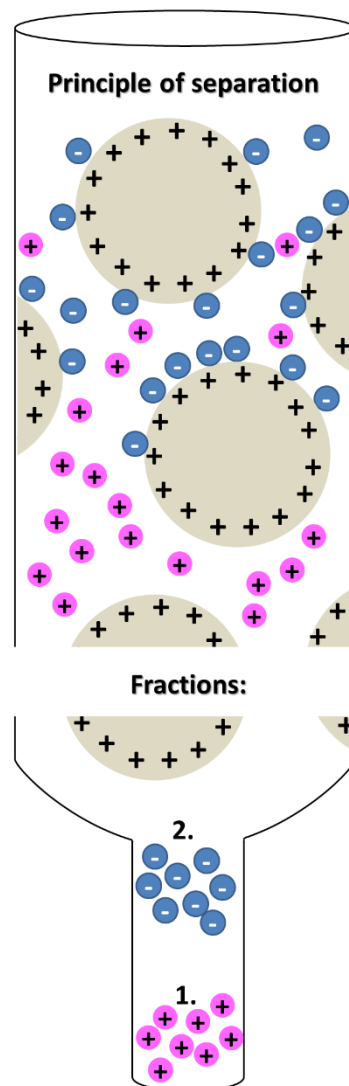

Principle of ion exchange chromatography. Dissociation of the functional groups creates a charge, which binds oppositely charged ions, on the surface of the ionex. The individual ions present in the sample bind to the exchanger with different forces, thus dividing them.

- **gel filtration chromatography („molecular sieve“)**

The stationary phase is a polymer gel of regular spatial arrangement, the mobile phase is a liquid. The components of the mixture are separated based on the different molecular sizes. Substances whose molecules are larger than the pore diameter in the gel cannot penetrate it and move forward with the mobile phase. Smaller molecules penetrate into spatial "meshes" and their movement slows down (see picture). The method is used mainly for the separation of macromolecular substances, proteins, enzymes, polysaccharides, etc.

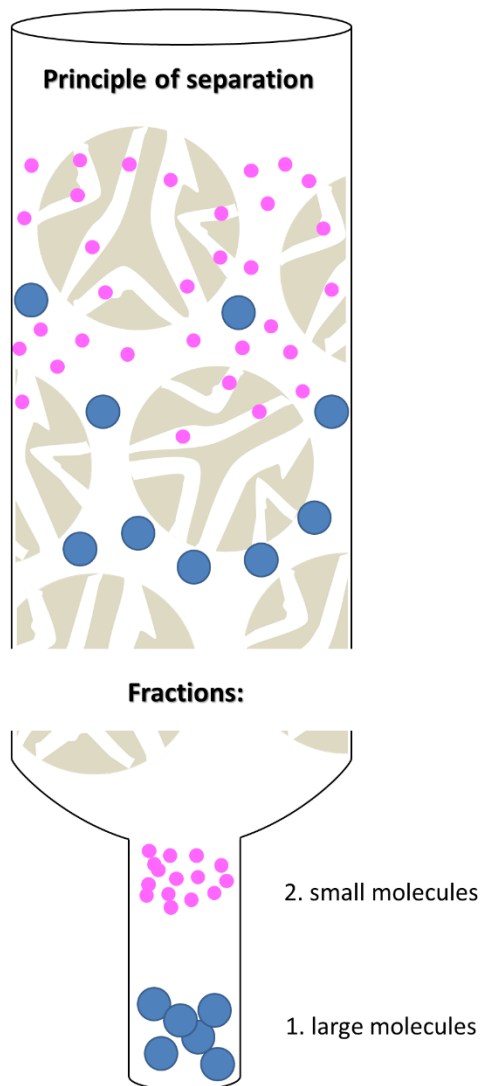

Principle of gel filtration chromatography. Small molecules enter the "corridors" in the gel, delaying them from molecules that do not fit into the pores in the gel. These large molecules of the "maze" in the gel particles bypass, are entrained with the mobile phase and leave the column first.

- **affinity chromatography**

The stationary phase is a polymer gel that has a substance (ligand) covalently bound on its surface, e.g. an antibody, with the ability to interact with the test sample (see figure), in the case of an antibody as a ligand with the relevant antigen. The mobile phase is usually buffers with different ionic strengths. The method is used for separation and isolation of bioactive substances (proteins, nucleic acids).

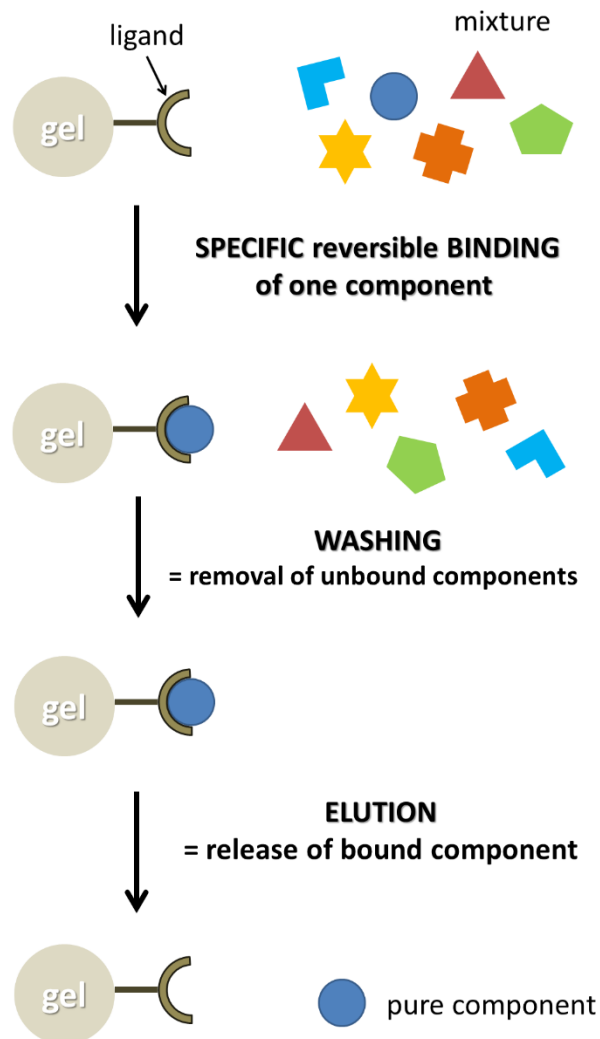

Principle of affinity chromatography. The ligand specifically binds one component of the mixture to itself, the other components are removed by washing. By changing the mobile phase, the ligand-bound component is released and an eluate containing only this isolated component is obtained.

Abbreviations derived from the names of the individual methods are used in chromatography.

Name of the method	abbreviation
gas chromatography	GC
liquid chromatography	LC
high-performance liquid chromatography	HPLC
paper chromatography	PC
thin layer chromatography	TLC
gel permeation chromatography	GPC
ion exchange chromatography	IEC

Evaluation of chromatographic methods

Column chromatography - during the elution, fractions are gradually collected, either by means of a timer at the same time intervals, or fractions of the same volume are collected with a suitable device. They are most often evaluated photometrically. A graphical representation of the elution process is the so-called *elution curve*. The elution time or elution volume is plotted on the x-axis and the absorbance measured on the y-axis. The elution of the isolated component has the shape of a curve that resembles a Gaussian curve in its distribution. Its height characterizes the amount of substance, its position (elution time or volume corresponding to the position of the maximum) can be used to identify it. The comparison is made using known standards.

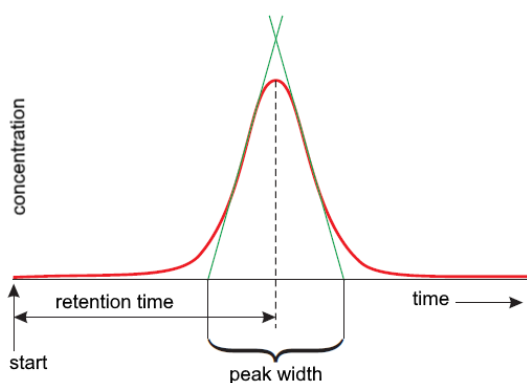

Planar chromatography - substances are usually only identified in this configuration. The place where the sample is applied is called the *start*, the position of the mobile phase at the moment of development interruption is the *solvent front*.

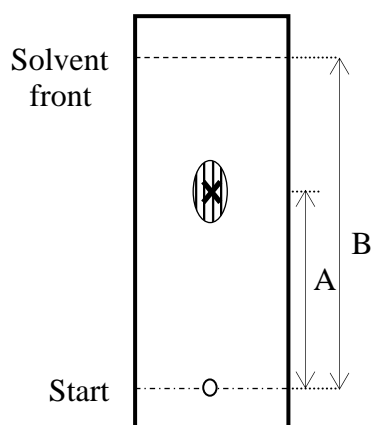

Identification is performed using a *retardation factor* (R_f). The retardation factor is the *ratio of the start - center of gravity of the sample spot* (A) to the *start - solvent front* (B).

$$R_f = \frac{A}{B}$$

The R_f values are given in the tables, but it is more reliable to compare the sample with the standards, which are applied in parallel with the test substance and evaluated in the same way.

Acid-base equilibria, pH

The problem of acid-base equilibria must be solved in connection with the theory of acids and bases. Due to its application in biochemistry, at this point it is possible to limit it to aqueous solutions. **Acids** are defined as substances that can *release a proton* (hydrogen cation). The stronger the acid is, the more readily releases the proton. **Bases**, on the other hand, are substances that *receive* more readily the proton, the stronger they are. Each acid forms an acid-base conjugated pair with its base. This pair differs only in proton. The strong acid forms a conjugated pair with the weak base and vice versa.

Acid \rightarrow Base + H^+	Conjugated pair
$HCl \rightarrow Cl^- + H^+$	strong acid / weak base
$H_2CO_3 \rightarrow HCO_3^- + H^+$	weak acid / strong base
$NH_4^+ \rightarrow NH_3 + H^+$	weak acid / weak base

A proton can be released from an acid only if it is accepted by the present base. Analogously, electron exchanges take place in redox processes.

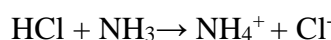
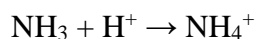
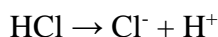

Water takes a very special position in these exchanges, because it can be both a proton donor even an acceptor, depending on the situation. If the ability to receive or deliver a proton is not clearly defined (as in the case of water), these substances are referred to as **ampholytes**.

Ampholyte acts as an H^+ donor in the presence of bases (acts as an acid). On the other hand, in the presence of acids it acts as an H^+ acceptor (acts as a base).

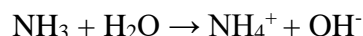
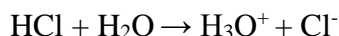
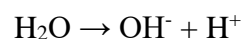
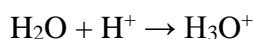
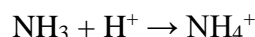
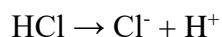

(water represents base)

(water represents acid)

Proton exchange occurs (although only to a limited extent) between two water molecules (so-called autoprotolysis).

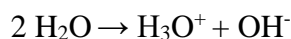

Molar concentration $c(H_3O^+)$ in water can be derived from the equilibrium of dissociation constant:

$$K_V = \frac{[H_3O^+] \cdot [OH^-]}{[H_2O]^2}$$

$$K_V \cdot [H_2O]^2 = [H_3O^+] \cdot [OH^-] = K_S$$

The square brackets indicate concentrations in moles per litre.

The constant K_s is called the **ionic product of water** and its numerical value is at 25°C:

$$K_s = 1.12 \cdot 10^{-14} \text{ mol}^2/\text{l}^2.$$

In water: $c(\text{H}_3\text{O}^+) = c(\text{OH}^-) = 10^{-7} \text{ mol/L}$

In acid solutions: $c(\text{H}_3\text{O}^+) > 10^{-7} \text{ mol/L}$

In alkaline solutions: $c(\text{H}_3\text{O}^+) < 10^{-7} \text{ mol/L}$.

Hydrogen exponent (pH)

The term hydrogen exponent (commonly pH) is a measure of acidity. It was introduced by S. P. L. Sørensen (1909) in an effort to simplify data of the concentration of hydrogen ions in solution by usage of logarithmic scale.

$$pH = -\log c(\text{H}^+) \qquad c(\text{H}^+) = 10^{-pH}$$

Analogically, other relations derived from the ionic product of water can be expressed by the logarithmic function.

$$pOH = -\log c(\text{OH}^-) \qquad c(\text{OH}^-) = 10^{-pOH}$$

$$pH + pOH = 14$$

The water has a pH of 7, in acidic solutions the pH is <7 , and in alkaline solutions the pH is >7 . The practical pH range in aqueous solutions is 0 to 14.

$$pH = 14 - pOH \qquad pOH = 14 - pH$$

Blood pH is monitored very carefully in clinical biochemistry. The normal value is 7.40 ± 0.04 , which corresponds to an H^+ concentration of 40 nmol/L (with a range of 36.5 to 44.0 nmol/L). When the pH scale is used, it is always necessary to be fully aware that it is a logarithmic range. A change of one pH unit means a ten-fold change in hydrogen ion concentration.

Calculation of pH of solutions of strong acids and hydroxides

Strong acids are those which are virtually completely dissociated in the dilute aqueous solutions. Their pH can be easily calculated. The concentration of hydrogen ions, which is used to calculate the pH, is dependent on the saturation of the relevant acid. The concentration of $c(\text{H}^+)$ in polybasic acid must be multiplied, of course.

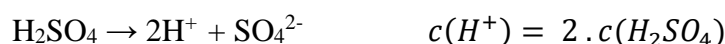

Alkali and alkaline earth metal hydroxides are strong hydroxides. They completely dissociate in water to a metal cation and hydroxide anion OH^- . This anion is a strong base and it removes protons from the reaction partner. The concentration of hydroxide anions required for pH calculation can be derived from the hydroxide concentration.

Calculation of pH of weak acid and hydroxide solutions

Weak acids are only partially dissociated in aqueous solutions. The degree of dissociation is dependent on the value of the dissociation constant. Weak acid HAc dissociation can be illustrated:

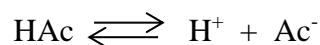

The equilibrium (dissociation) constant (K_a) for this reaction is:

$$K_a = \frac{[\text{H}^+].[\text{Ac}^-]}{[\text{HAc}]}$$

The square brackets indicate concentrations in moles per litre.

The larger the constant, the stronger the acid, and vice versa. For very small K (which is quite frequent) it is convenient to use pK where $pK = -\log K$.

The dissociation equation implies that $[\text{H}^+] = [\text{Ac}^-]$, then

$$K_a = \frac{[\text{H}^+]^2}{[\text{HAc}]}$$

and

$$c(\text{H}^+) = \sqrt{K_a \cdot c(\text{HAc})}$$

The symbol $c(\text{HAc})$ represents the concentration of present undissociated weak acid molecules. In view of the fact that the dissociation takes place only to a small extent and there is negligible effect on the total acid concentration (c_a), the $c(\text{HAc})$ concentration is considered as the total concentration of present acid concentration (c_a). After introducing logarithm, using pH and pK_a ($pK_a = -\log K_a$), the final expression for **calculating the pH of weak acids** is obtained:

$$\text{pH} = \frac{1}{2} \cdot (pK_a - \log c_a)$$

Analogously, a similar relationship for pH **calculating of weak hydroxides** can be derived:

$$\text{pH} = 14 - \frac{1}{2} \cdot (pK_b - \log c_b)$$

pH measurement

Determination of pH is one of the basic tasks in the laboratory and even in chemical practice. Simple colorimetric methods as well as exact pH-meters are used. Colorimetric methods use various acid-base indicators most often impregnated on a strip of paper. The estimation accuracy is about ± 0.2 pH units. With modern pH meters based on the principle of potentiometry, pH can be measured with the accuracy of a hundredth of pH units.

Colorimetric pH measurement

The measurement is based on observation of colour changes of acid-base indicators. These indicators change their colour depending on the concentration of H^+ ions in the solution. Only (two-colour) bicolour indicators that change from one colour to another within a specific pH range are suitable for measurement.

The indicator (I) acts as a weak acid or a weak base. We consider the more frequent case, *i.e.* the (two-colour) bicolour indicator HI, which is a weak acid. Its dissociation in water is expressed by dissociation equation:

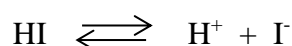

The equilibrium dissociation constant K_i is:

$$K_i = \frac{[H^+].[I^-]}{[HI]}$$

After introducing logarithm can be derived:

$$pH = pK_i + \log \frac{[I^-]}{[HI]} = pK_i + \log \frac{[base]}{[acid]}$$

If the forms $[I^-]$ and $[HI]$ are different in colour, then the derived equation implies that if there is the pH change of the solution, there is the change of the components ratio, and it is associated with the colour change. The colour change can be visible if at least 10% of one of the forms of the indicator is present, suggesting that significant colour changes occur within the range of $pH = pK_i \pm 1$. It is the basis of the colorimetric pH measurement.

methyl red



It is very simple to determine pH *using indicator papers*. There is on the universal indicator paper a scale segmented into 18 colour comparative fields for pH ranging from 0 to 12, with an accuracy estimate of ± 0.5 pH. For more accurate pH determination, there are used papers produced in the Czech Republic under the name **PHAN**. There is an indicator segment in the middle, and there are printed comparative colour strips on both sides, which colour tone corresponds to certain pH values. The pH values are indicated for each type of paper on the enclosed scale, segmented mostly by 0.3 pH. Accuracy of measurement under all conditions is ± 0.15 pH.

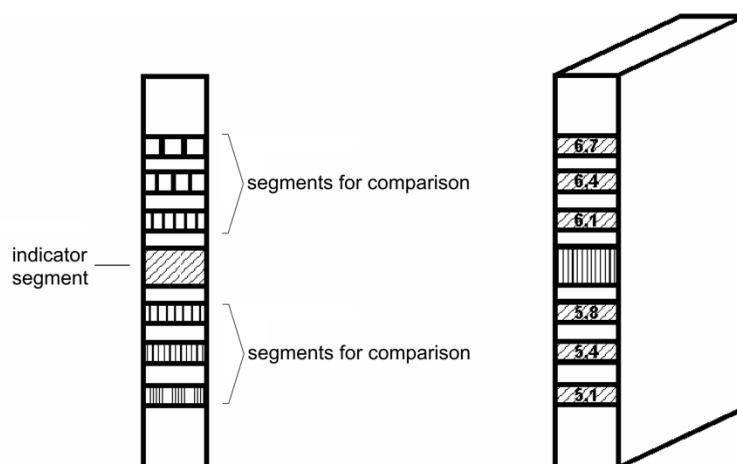

In practice, there are proved various special indicator strips designed for environments where conventional papers fail, for example to determine the pH of heavily coloured or cloudy solutions. Special purpose papers are also used in the food industry (acidity of milk, cheese or curd), agriculture (soil reaction, silage control), clinical biochemistry (urine examination), etc.

Determination of pH using buffers

If there is the approximate pH of the examined solution known, an appropriate indicator that colour transition is within the predicted pH range is selected. Buffers are used as reference solutions in which the pH was determined by accurate electrometric measurement. The determination is simple. The same amount of appropriate buffers that differ typically in 0.2 pH are pipetted into a series of identical tubes. The same sample volume is placed in another tube. Then the same amount of indicator is added to all tubes. The colour of the examined sample is compared with the coloration of the buffers.

Potentiometry

Substances that show an electric charge can be quantitatively determined by *potentiometry*. It is an electrochemical method based on measuring the potential difference between two electrodes.

Generally, the electrode is a system of conductive interconnected electrical phases. Practically, it is an electrical conductor that is in a direct contact with something else conductive, usually an electrolyte. There are many of different types of electrodes depending on their design and the processes that proceed on them.

In principle, the simplest ones are the electrodes of the first kind. They consist of an element (metal for most electrodes, rarely a gas, *e.g.* hydrogen) and its ion contained in a solution. For example, a zinc electrode is formed by immersing a zinc sheet in a solution containing Zn^{2+} cations.

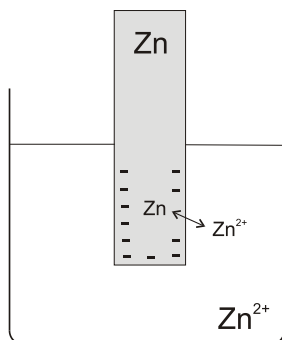

$$E_{\text{Zn/Zn}^{2+}} = E_{\text{Zn/Zn}^{2+}}^0 + \frac{RT}{2F} \ln [\text{Zn}^{2+}]$$

Standard electrode potential: $E_{\text{Zn/Zn}^{2+}}^0 = -0.763 \text{ V}$

Scheme of zinc electrode

More precisely, the effective concentration is represented by the term **activity**, which is related to the actual concentration by a simple relation, *e.g.* for substance A:

$$a_A = \gamma_A \cdot [A]$$

a_A ... substance A activity

$[A]$... equilibrium concentration of substance A

γ_A ... molar activity coefficient (difference between activity and concentration caused by interaction of A particles with other particles in the reaction solution)

The difference between activity and concentration decreases with dilution of the solutions. With respect to that the solutions of the internal environment of the organism are mostly vastly diluted, there is no need to distinguish concentration and activity.

Potentiometric cells are composed of two electrodes. An electrode which potential is not influenced by the concentration of the examined substance and there is a fixed electrode potential value, it is named as a **reference electrode**. For example, silver chloride (Ag / AgCl), calomel (Hg / Hg₂Cl₂) or mercury sulphate (Hg / HgSO₄) electrodes are used.

An electrode that changes its electrode potential as a function of changes of the concentration of the analyte is named as an **indicator electrode**. Electrodes made of metal which ions are contained in the solution to be measured or membrane ion selective electrodes (glass) are used as indicator electrodes.

If the concentration of the measured component is determined directly from the value of the electromotive force of the potentiometric cell, it is a direct potentiometry (pH measurement).

Indirect use of potentiometry is *e.g.* potentiometric titration. A curve with a characteristic S-shape is graphical representation of the titration with a potentiometric indication.

History

The **Hehrad** study on the determination of mercury halides in 1893 is considered to be the first potentiometric work. In the same year, **Le Blanc** used hydrogen electrodes to determine the concentration of hydrogen ions. Potentiometric measurement was gradually becoming more common, new indicator electrodes were tested; especially a glass electrode. The ability of glass membranes to



F. Haber

respond by hanging their potential to changes in the concentration of hydrogen ions was discovered in 1906 by **M. Cremer**. The first acid-base measurement was performed by **F. Haber** and **Z. Klemensiewicz** in 1909.

The electromotive force of the potentiometric cell U (also denoted by ΔE) is given by the difference of equilibrium potentials of the **indicator electrode** (E_{ind}) and the **reference electrode** (E_{ref})

$$\Delta E = E_{\text{ind}} - E_{\text{ref}}$$

Depending on the design of a particular electrode, its potential is stated by either the electrode potential or the membrane potential.

The **electrode potential** is generated at the electrode / electrolyte interface. If an electrochemical reaction occurs on the electrode according to the equation

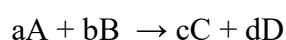

the equilibrium electrode potential depending on the concentrations (activities) of the reactants can be expressed by the **Nernst equation**:

$$E = E^0 - \frac{RT}{zF} \ln \frac{[C]^c \cdot [D]^d}{[A]^a \cdot [B]^b}$$

E^0	standard electrode potential of redox pair (from tables)
R	gas constant ($8.314 \text{ J}\cdot\text{mol}^{-1}\cdot\text{K}$)
T	absolute temperature [K] (temperature in $^{\circ}\text{C} + 273.15$)
F	Faraday constant ($96485.3 \text{ C}\cdot\text{mol}^{-1}$)
Z	the number of electrons exchanged in the reaction
$[A], [B], [C], [D]$	equilibrium concentrations raised to corresponding stoichiometric coefficients

Walther Hermann Nernst (1864 – 1941) was a German chemist. He received the Nobel Prize in 1920 for his work in the field of thermochemistry. Nernst helped to establish modern physical chemistry and contributed to the fields of electrochemistry, thermodynamics and photochemistry.



W.H. Nernst

Membrane potential arises at the membrane / electrolyte interface when the membrane is permeable only for some kinds of ions and not for others. In other words, the membrane is permeable to solvent and some ions, but not all. The consequence of it is the formation of the **Donnan potential** on both sides of the membrane and the membrane potential, which is their difference ($\Delta\phi$) and is described by:

$$\Delta\phi = \frac{RT}{zF} \ln \frac{c_1}{c_2}$$

derived from the Nernst equation.

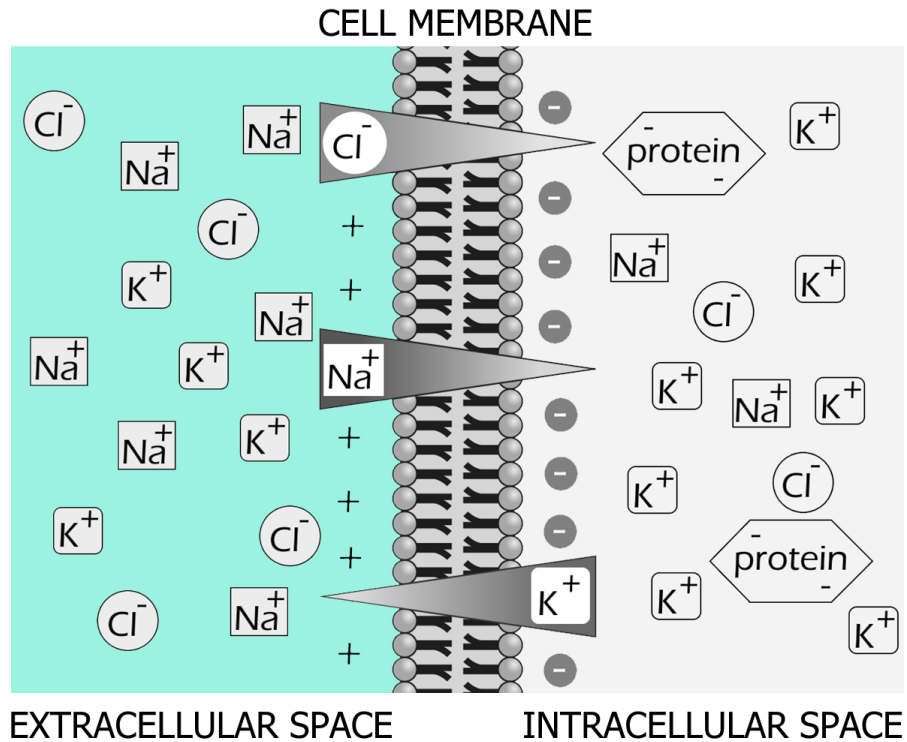

Example of (Donnan) membrane equilibrium on cell membrane. The triangles show the potential gradient of the respective ions. The solution on one side contains proteins that cannot cross the membrane. Therefore, they are unevenly distributed between the solutions on both sides of the membrane, therefore there will be a non-zero potential difference ($\Delta\phi \neq 0$) between the two sides of the membrane.

The presence of ions for which the membrane is impermeable will cause uneven distribution of the other ions between the solutions on both sides of the membrane.

Potentiometric pH measurement

pH electrodes

Hydrogen electrode

The convention states that a standard hydrogen electrode is constructed as a platinum sheet coated with platinum black, immersed in a solution with hydrogen ion of activity $a(\text{H}^+) = 1$, saturated with hydrogen under a pressure of 101.325 kPa. Platinum black catalyses the dissociation of molecular hydrogen into atomic, which is in equilibrium with hydrogen ions according to the formula:

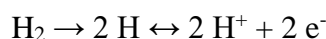

The hydrogen electrode potential is an initial point for determining the potentials of the other electrodes. It means *standard potential* of the hydrogen electrode is considered to be zero for all temperatures.

Using this electrode, the relative electrode potentials of metals immersed in solutions of their own salts were measured. Based on these potentials, the electrochemical series of metal was assembled by *N. N. Beketov*: Li, Rb, K, Na, Ba, Sr, Ca, Mg, Al, Be, Mn, Zn, Cr, Fe, Cd, Co, Ni, Sn, Pb, H, Sb, Bi, As, Cu, Hg, Ag, Pt, Au. Metals on the left of hydrogen show a negative potential, metals on the right of hydrogen show a positive potential.

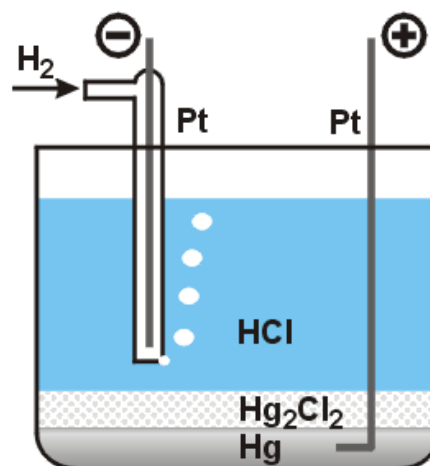

Glass electrode

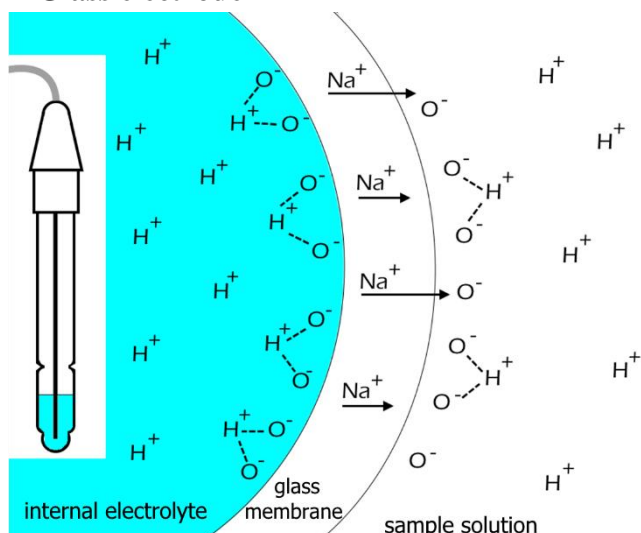

The glass electrode is a membrane electrode. The membrane is a thin-walled flask made of special soda-lime glass. The internal electrolyte is a buffer (to maintain a constant pH) into which an internal reference electrode, usually silver chloride, is immersed. Hydrolytic release of sodium cations from the glass and their exchange with hydrogen cations from the solution is underway the action of water from the measured solution.

The advantage of the glass electrode is that the measurement is not influenced by the presence of oxidation-reduction systems, heavy metal ions, proteins, surfactants or some organic solvents.

Other types of pH electrodes

Metallic - oxide electrodes

The electrodes of metals (Sb, Bi, Te) consist of a small stick of pure metal, on which surface, after immersion in a specific solution, a film of the respective oxide is formed.

Quinhydrone electrode

It consists of a platinum wire immersed in a solution saturated with quinhydrone.

Reference electrodes

Silver chloride electrode

It consists of a silver wire (or platinum wire with electrolytically deposited silver) covered with silver chloride immersed in a solution of potassium chloride saturated with silver chloride. It is used in a cell with a specific glass electrode.

Mercury chloride electrode

It consists of a mercury electrode coated with a suspension of mercury chloride (calomel, Hg_2Cl_2) in potassium chloride solution.

Combined electrodes

For practical reasons, the indicator and reference electrodes are often combined into one unit. These electrodes are called combined. They achieve the same accuracy and sensitivity as a separate electrode system.

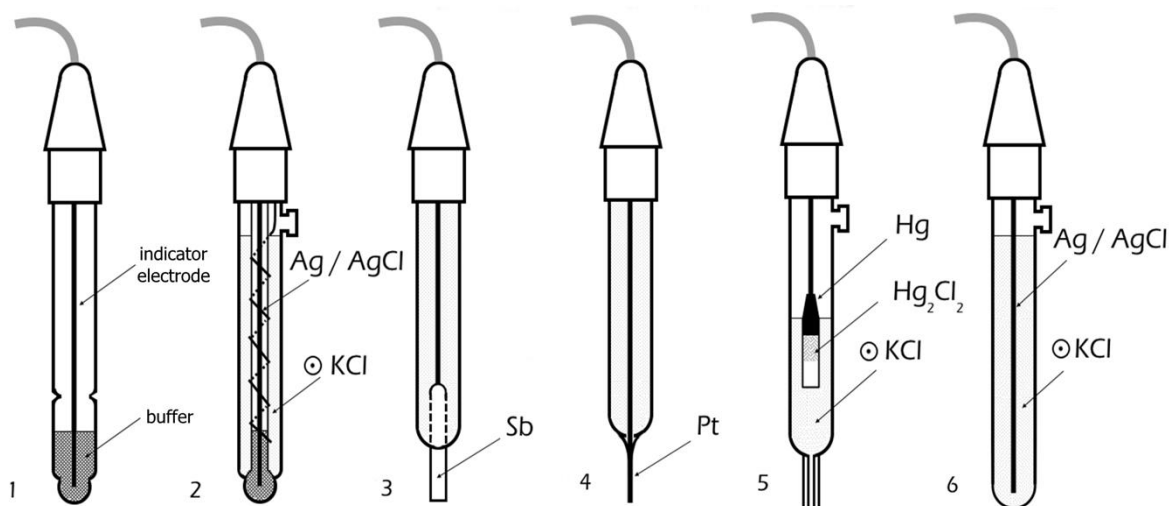

pH electrode types:

1 – glass, 2 – combined glass (with reference electrode), 3 – antimony, 4 – platinum, 5 – mercury chloride, 6 – silver chloride

Direct potentiometry

Direct potentiometry is a method which the concentration (activity) of an ion or molecule determines by means of a potentiometry cell formed by an indicator and reference electrode. The cell together with the voltmeter measure the electromotive force which directly corresponds to concentration (activity) of the sample.

Potentiometric titration (indirect potentiometry)

Potentiometric titration monitors the dependence of the potential between two electrodes (or pH in neutralization titration) on the volume of added titrant. The titration is not stopped at the equivalence point, the full titration curve is constructed.

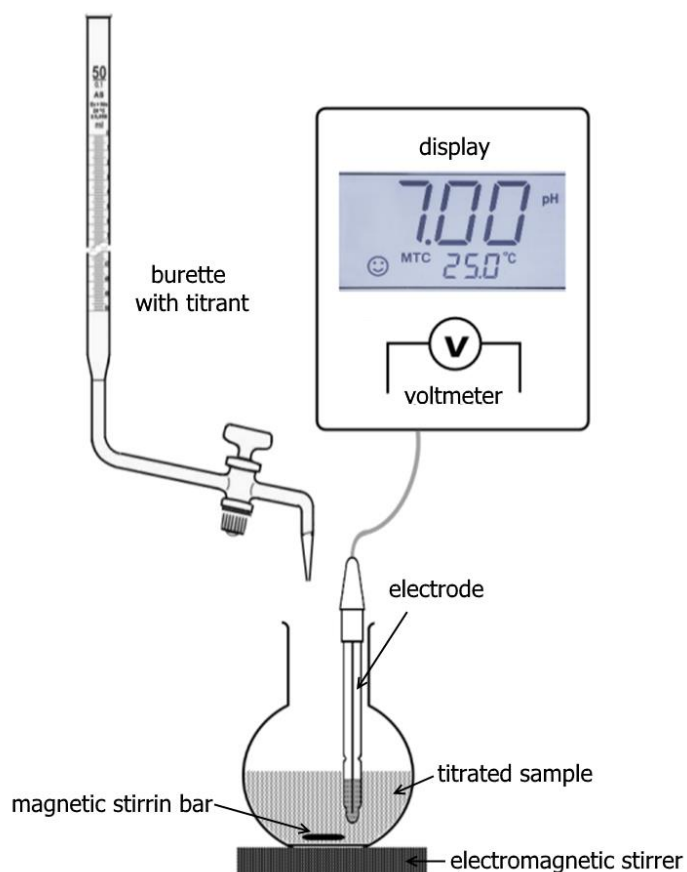

The titration is not stopped at the equivalence point, the full titration curve is constructed.

The progress of neutralization, precipitation, complex and redox titrations is similar and the resulting titration curve is characterized by S-shape. The consumption of the titration solution at the equivalent point is read from the graph or obtained by calculation. There are several advantages of this type of titration:

- objectivity
- no need to use the indicator
- cloudy or coloured solutions may also be titrated

Calibration of pH meter

The pH meter should be calibrated before pH potentiometric measurement. Then the actual measurement is performed. Calibration of the pH meter is performed by assigning the respective pH value of calibration buffers (usually pH=7 and pH=4) to their measured voltage values.



Buffers

In chemical practice, solutions with a particular pH value are required for various purposes. Moreover, the pH values need to be retained under various external influences. This requirement can be met in the strongly acidic and strongly alkaline range by appropriate dilution of the strong inorganic acids and hydroxides, respectively. In the middle range of the pH scale (about 3 to 11), it is accomplished by so-called *buffer solutions* or *buffers*. These solutions are able to substantially moderate (attenuate) the pH change that would otherwise occur due to external action.

The buffer systems consist of two components: a weak acid and its conjugated base, or a weak base and its conjugated acid. In the first case, there is the same anion for both components, a *common anion* (e.g. CH₃COOH and CH₃COONa), in the second case, there is the same cation for both components, a *common cation* (e.g. NH₄OH and NH₄Cl).

The function of the buffers can be well explained by the use of, for example, an acetate buffer consisting of a mixture of acetic acid and sodium acetate solution. Acetic acid is a weak protolyte, which is only ionized weakly. Its dissociation is further suppressed by the present CH₃COO⁻ ions, which are formed by dissociation of its salt. The salt is fully ionized. The buffer contains undissociated acetic acid and its conjugate base, the acetate ion. If this solution is acidified, the added H⁺ ions immediately react with the acetate ions to undissociated CH₃COOH and the pH of the solution does not change much.



Conversely, if a solution of a strong base (e.g. NaOH) is added, the reaction with acetic acid proceeds again without significant pH variation.

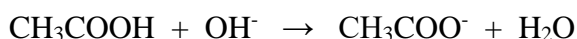

The ammonia buffer (NH₄OH / NH₄Cl) also behaves in an analogous manner. Acid impact attenuates ammonium hydroxide (I.), pH change induced by strong hydroxide attenuates the ammonium chloride present (II.)

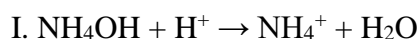

Henderson-Hasselbalch equation

A buffer is a system of two components with a common anion or cation. For example, if acetic acid and sodium acetate are mixed in an aqueous medium, the following reactions occur:

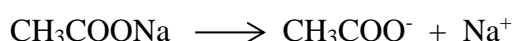
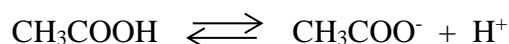

The dissociation constant (K_A) of acetic acid is:

$$K_A = \frac{[\text{CH}_3\text{COO}^-] \cdot [\text{H}^+]}{[\text{CH}_3\text{COOH}]}$$

The dissociation of acetic acid is strongly suppressed by the present CH_3COO^- ions. Therefore, the concentration of acetate ions $[\text{CH}_3\text{COO}^-]$ can be considered as the substance concentration of salt in the total buffer volume (c_s) and the concentration of undissociated acetic acid $[\text{CH}_3\text{COOH}]$ as the substance concentration of acid in the total buffer volume (c_A):

$$K_A = \frac{[\text{H}^+] \cdot c_s}{c_A}$$

$$c_{(\text{H}^+)} = \frac{K_A \cdot c_A}{c_s}$$

After introducing logarithm, we get an expression called the **Henderson-Hasselbalch equation**, which is used to calculate the pH and the composition of buffer systems.

$$\mathbf{pH = pK_A + \log \frac{c_s}{c_A}}$$

The symbols c_s and c_A indicate the substance concentrations of the components in the whole buffer volume. The Henderson-Hasselbalch equation can be adjusted to a mass quantity form, which can be advantageously used in most calculations:

$$\mathbf{pH = pK_A + \log \frac{n_s}{n_A}}$$

Analogously, an alkaline pH buffer can be prepared from a mixture of a weak base solution and its conjugated acid, *e.g.* ammonia and ammonium chloride. With a similar reasoning as in the previous case, it is possible to derive the Henderson-Hasselbalch equation, in the form for these cases:

$$\mathbf{pH = 14 - \left(pK_B + \log \frac{n_s}{n_B} \right)}$$

Solutions of weak acids and their salts are used for the preparation of buffer systems. Hydrogen salts are also suitable, such as NaH_2PO_4 and Na_2HPO_4 pairs. A salt with a plurality of hydrogen atoms represents an acid.

Another possibility to prepare buffers is to partially neutralize the acids or bases with the calculated amount of the relevant reagent. For example, in acetate buffer, there can be replaced sodium acetate by acetic acid and NaOH, or ammonium chloride by reaction of ammonia with HCl in ammonium buffer.

By mixing several buffer systems, buffers effective over a wide pH range can be obtained. For example: Britton-Robinson Universal Buffer is a mixture of H_3PO_4 , CH_3COOH a H_3BO_3 , to which is added a prescribed amount of NaOH, which, due to trihydric phosphorous acid, represents five buffer systems covering the entire pH range of 2 to 12. The table shows the most common buffers:

Buffer	pH range
citric acid - sodium citrate	3.06 ± 1
acetic acid - sodium acetate	4.75 ± 1
NaH ₂ PO ₄ - Na ₂ HPO ₄	7.21 ± 1
H ₃ BO ₃ - Na ₂ B ₄ O ₇	9.24 ± 1
NH ₄ OH - NH ₄ Cl	9.25 ± 1
Na ₂ HPO ₄ - Na ₃ PO ₄	12.32 ± 1
H ₃ PO ₄ - CH ₃ COOH - H ₃ BO ₃ - NaOH	1.8 - 12

Function of buffers

The purpose of buffer systems is to prevent large changes of pH in the solution. The importance of buffers is extraordinary. They are involved in many chemical processes in solutions, including biochemical, and are an essential part of the regulatory systems of living organisms. Several factors limit their effectiveness.

The first limiting factor is the value of the dissociation constant pK_A (or pK_B). The buffer has *maximum buffering capacity* when it is

$$\begin{array}{ll} pH = pK_A & \text{then it is } n_s = n_A \\ \text{resp. } pH = 14 - pK_B & \text{then it is } n_s = n_B \end{array}$$

Solutions still have good buffering capacity when it is:

$$\frac{n_s}{n_A} = \left(\text{resp. } \frac{n_s}{n_B} \right) = \frac{1}{10} \text{ to } \frac{10}{1}$$

This ratio defines the so-called *buffering region*. Thus, each single buffer is useful in the range:

$$pH = pK_A \pm 1 \quad \text{resp. } pH = 14 - (pK_B \pm 1)$$

Another factor that affects the properties of a buffer is *the amount of substance of buffer components* in the buffer. The Henderson-Hasselbalch equation suggests that the ratio of the components affects the pH, while their amount affects the buffer capacity.

The *buffering capacity* indicates the *amount of the substance of strong acid or hydroxide that causes the change of pH by one unit*. The capacity is dependent on the amount of substance of buffer components. If the buffer contains more salt, it is better resistant to the acid attack. Conversely, if it contains more acid, it is better resistant to the attack of the alkali. If both components are represented equally, they are balanced on both sides. The so-called total buffer concentration is given by the relation:

$$c_p = \frac{n_p}{V_p} = \frac{n_s + n_A}{V_p} \left(\text{resp. } = \frac{n_s + n_B}{V_p} \right)$$

- c_p total buffer concentration
- n_p total amount of substance of buffer components
- V_p buffer volume

Volumetric analysis

Volumetric analysis is a quantitative analytical method. As the name implies, this method involves the measurement of volumes. It is based on the addition of a reagent of exactly known concentration (a “standard solution”) until a definite reaction with the substance is quite accurately completed.

A defined chemical process (neutralization, oxidation and reduction or ion exchange), which can be unambiguously described by a stoichiometric equation, must proceed rapidly and without side reactions between the two reactants.

Different volumetric methods can be divided into two main groups according to the type of reaction:

Methods based on the combination of ions:

- a) acid-base $\text{H}^+ + \text{OH}^- \rightarrow \text{H}_2\text{O}$ (water is formed)
- b) precipitation $\text{Me}^+ + \text{X}^- \rightarrow \text{MeX}$ (an insoluble precipitate is formed)
- c) complexometric $\text{Me}^+ + \text{X}^- \rightarrow [\text{MeX}]$ (an undissociated complex is formed)

Methods based on electron transfer - redox titrations:

- a) oxidimetry $\text{X} \rightarrow \text{X}^{n+} + n \text{e}^-$ (the sample is oxidized)
- b) reductometry $\text{Y}^{n+} + n \text{e}^- \rightarrow \text{Y}$ (the sample is reduced)

The name of the titration method is derived from the titration solution. It is either general (alkalimetry, acidimetry, oxidimetry) or special, derived from the titration agent used (manganometry, iodometry, argentometry).

In general:

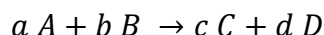

The ratio of amounts of substance of reactants can be expressed in small whole numbers (Dalton’s Law):

$$\frac{n_A}{n_B} = \frac{a}{b}$$

$$n_A = \frac{a}{b} \cdot n_B$$

Volumetric analysis (titration) is used to measure volumes (hence volumetric analysis) and compare concentrations of both reactants (optionally, amount of substance or weight):

$$c_A \cdot V_A = \frac{a}{b} \cdot c_B \cdot V_B \quad \left(\frac{m_A}{M_A} = \frac{a}{b} \cdot c_B \cdot V_B \right)$$

Substance A is always the sample or standard solution. For better clarity, all data associated with them are denoted by -s- for sample or -st- for standard. We call compound B a titration solution (TR) and use the -t- index for all symbols. (The titration solution is also referred to as titration reagent or titrant.) The stoichiometric ratio of reactants a / b will be referred to as the titration factor (symbol - f -) derived from the titration reaction. Thus:

$$\begin{aligned} c_s \cdot V_s &= c_t \cdot V_t \cdot f_s & f_s &= \frac{n_s}{n_t} \\ c_{st} \cdot V_{st} &= c_t \cdot V_t \cdot f_{st} & f_{st} &= \frac{n_{st}}{n_t} \end{aligned}$$

Volumes V_s , V_{st} , V_t are always given in milliliters, for volume V_t we use the symbol consumption. The concentration of the titration solution (c_t) is obtained in the units required for the sample, *i.e.* in mol / L (if the concentrations are very small in mmol / L).

The quantification of a sample should be done with great attention before each titration. If the sample is a solid, the required amount of sample is accurately weighed on an analytical balance, dissolved completely in distilled water and titrated. If the sample is a solution, it can also be weighed, but the appropriate volume is measured more often. Pipettes are used for this purpose. They are measuring containers and calibrated to pour, *i.e.* the required volume corresponds to the amount of solution that has leaked from the pipette.

The sample is titrated in the titration flask (glass wide-necked flask). Its size is chosen with respect to the sample volume. If there is titrated small volumes, it is advisable to add distilled water for better monitoring of the process. If a certain amount of additional solution should be added to the sample (*e.g.* to achieve suitable reaction conditions), a bottle top dispenser may be advantageously used. It is necessary to stir the content of the flask constantly during the titration. The use of an electromagnetic stirrer is suitable too. The sample is automatically mixed and the operator can concentrate fully on monitoring the titration.

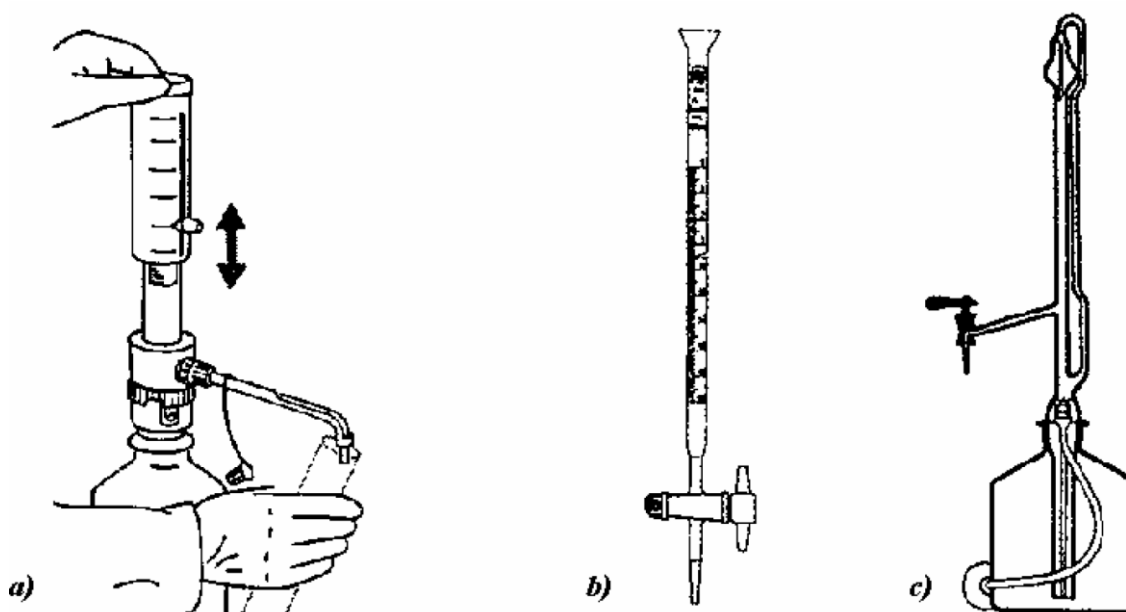

a) bottle top dispenser, b) burette, c) automatic burette

The titration solution is added to the sample from the burette. Selection of the titration solution depends on the type of titration method. It is prepared from chemicals of the highest chemical purity in a concentration that is of the same of the order (of magnitude) of the sample. The exact concentration of the titration solution is determined by so-called standardization just before using it. This is mainly due to an unstableness of some titration solutions. For this purpose, suitable substances, the so-called *standards*, are recommended from which the defined solutions in accurate concentration can be prepared. These are *e.g.* oxalic acid for alkalimetry and manganometry, sodium tetraborate for acidimetry, sodium chloride for argentometry and so on.

$$c_t = \frac{c_{st} \cdot V_{st}}{V_t \cdot f_{st}}$$

The concentration given in mol / L is calculated to three significant numerals (*e.g.* 0.105 mol / L or 0.0508 mol / L), for concentrations given in mmol / L to one decimal place (*e.g.* 105.1 mmol / L or 50.8 mmol / L). Next, the calculated concentration (c_t) is substituted for the calculation of sample concentration:

$$c_v = \frac{c_v \cdot V_v \cdot f_v}{V_t}$$

The decisive moment in the process of titrations is absolutely accurate and unambiguous recognition of the end of titration, finding the so-called ***equivalent point***. This can be determined subjectively (for visual titration) or objectively (for titration using instruments).

In subjective evaluation, the visual change of the sample at the equivalent point should be determined with the greatest possible accuracy. This can be:

1. colour change: (a) colourless solution to colour
(b) a marked change in colour
(c) decolourizing the solution
2. formation of a precipitate (the solution becomes cloudy at the end of the titration)
3. origin or extinction of fluorescence

These changes can be observed directly in some titration methods (so-called autoindication titrations). In such cases, the titration solution is coloured and it is discoloured during the titration by conversion to a colourless product. Examples are manganometry (reddish-purple KMnO_4 is reduced to colourless Mn^{2+} ions) or iodometry (reddish-brown iodine solution is reduced to colourless iodide).

In other cases, indicators must be used. They are added to the sample at the beginning of the titration. At the equivalent point, a colour change occurs due to the indicator that reacts with the first excess titration drop. The choice of the indicator is essential for the titration and it is always necessary to realize that each any such titration is burdened with a certain indicator error. A suitable indicator can minimize this error.

In the case of objective titration, problems with the indicators are eliminated. The course of titration is monitored by measuring a suitable physical quantity (electrode potential for potentiometric titration or conductivity for conductometry). The evaluation is carried out using the so-called titration curves. Most titrations are performed directly. However, if the reaction proceeds slowly, an indirect assay may be used. It is carried out by adding an excess of reagent R to the substance to be examined, which is then titrated with a suitable titrating agent.

$$n_s = n_R - n_t$$

$$c_s = \frac{(c_R \cdot V_R) - (c_t \cdot V_t)}{V_s}$$

Acid-base titration / Neutralization titration

Acid-base titrations include two volumetric methods: alkalimetry and acidimetry. The concentration of acidic solutions is determined by alkalimetry. The concentration of basic solutions is measured by acidimetry. In principle, strong protolyte solutions are used as titrating agents: Sodium hydroxide for alkalimetry, hydrochloric acid for acidimetry.

The end of the titration is determined by acid-base indicators. They are dilute (approximately 0.1%) aqueous or ethanolic solutions of organic compounds from the group of phthaleins, sulfophthaleins and azo dyes which colour is pH-dependent. The choice of the indicator depends on the titration curve, which expresses the pH dependence on the volume of the added titration solution. These curves have a characteristic S-shape. The indicator should be selected so that the pH range of its colour transition is located in the steep part of the titration curve.

For strong protolytes (strong acids and bases) there is a sharp change in pH at the equivalent point, which results in a "jump" on the titration curve. Therefore, it is possible to choose from a number of indicators that meet the requirements above. For weak protolytes (weak acids and bases), the pH change is considerably less and the choice of indicators is limited. For very weak protolytes, the "jump" is extremely small and it is difficult to find a suitable indicator for visual titration. The weakest protolytes cannot be titrated visually.

Acidobasic indicators

Name	Acid solution	Basic solution	pH range
Methyl orange	red	orange	3,0 - 4,4
Methyl red	red	yellow	4,4 - 6,2
Neutral red	red	yellow	6,0 - 8,0
Thymol blue	yellow	blue	8,0 - 9,6
Phenolphthalein	colourless	pink	8,2 - 9,9

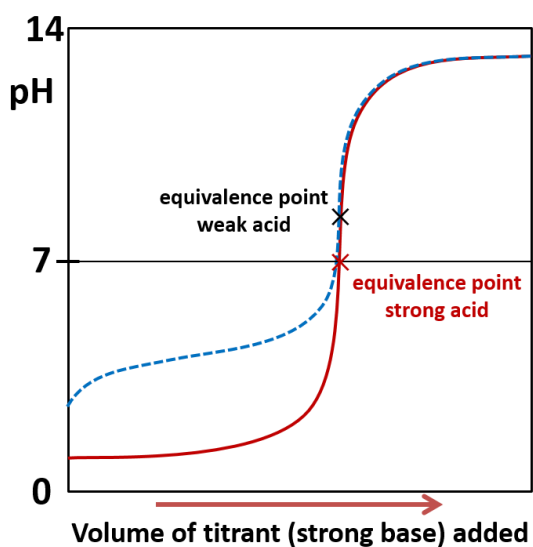

Titration curve for alkalimetric titration of *strong* and *weak* (dashed line) acid

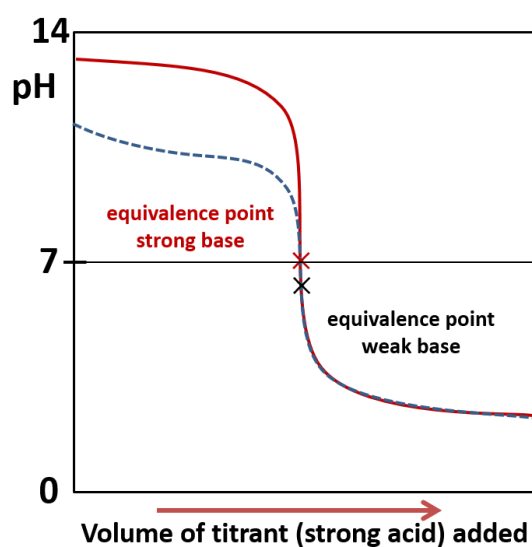

Titration curve for acidimetric titration of *strong* and *weak* (dashed line) base

As it is evident from the course of the titration curves and the colour transitions of the indicators, a strong and weak protolyte can be titrated side by side with a suitable selection of a pair of indicators. It can be used, for example, to determine acidity of gastric juice, titration of carbonates besides NaOH, strong acids besides weak, polyhydric acids up to several degrees, etc.

All titrations are performed minimally twice. The first determination is indicative, the second one carefully monitors the equivalent point area. The found consumption must not differ by more than 0.2 mL. If the differences are greater, it is necessary to repeat the titration.

Alkalimetry

Most often, a titration solution of NaOH ($c = 0.1 \text{ mol / L}$) is, which is prepared from the compound of the highest analytical purity (p.a.). A known weight is dissolved to make a specific volume. However, it must be taken into account that NaOH reacts with water and CO_2 in the air, so the exact concentration is determined by standardization just before its use. For a long-term stored solutions, the examination should be repeated regularly.

Oxalic acid $(\text{COOH})_2 \cdot 2 \text{ H}_2\text{O}$ is used as a standard. It is prepared from the calculated weight of its crystalline substance. The selection of the indicator is according to the course of a titration curve. Mostly, methyl orange (for strong acids) and phenolphthalein (for weak acids) are sufficient. Strong and weak acids and acid-reacting salts are titrated.

Complexometric titration

The principle of these titration method is the formation of undissociated but water-soluble complexes of metal cations with a complexing agent. For titration purposes there is used:

- reaction of cations with aminopolycarboxylic acids (chelatology)
- formation of mercury complex salts (mercurimetry)

In chelatology, the titrant is a ligand of the resulting complex. In mercurimetry, on the contrary, the titrating solution provides a central cation, the ligand is the sample anion.

Chelatology

Chelatometric titration agents are referred to complexones. They are aminopolycarboxylic acids derived from iminodiacetic acid.



Specifically, it is

- nitrilotriacetic acid (NTA) - complexon I

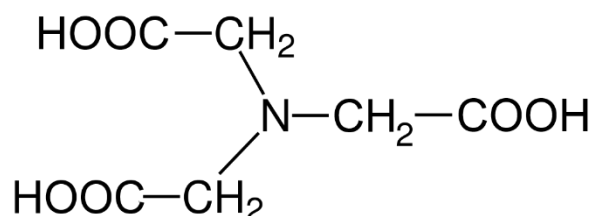

- ethylenediaminetetraacetic acid (EDTA) - complexon II

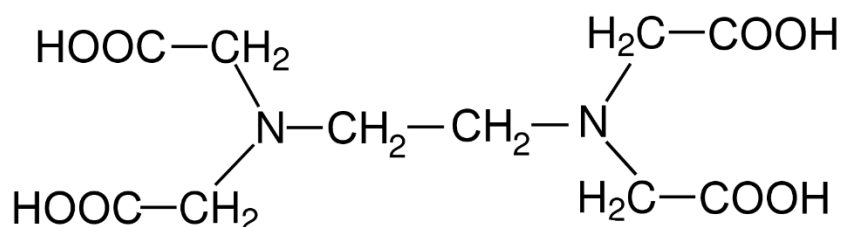

- disodium salt of ethylenediaminetetraacetic acid - complexon III

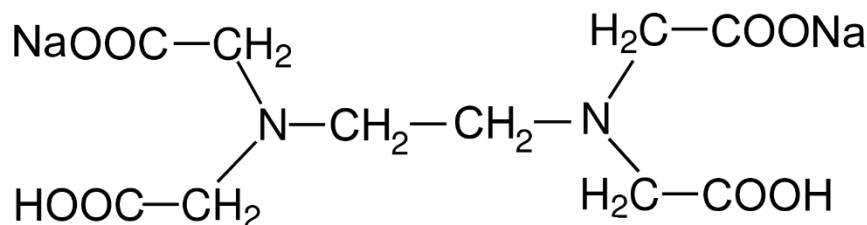

Disodium salt of ethylenediaminetetraacetic acid is the most used because it is the most soluble of these compounds. It is used as a titration agent in chelatology, as a water softener (it binds to the complex calcium and magnesium ions that cause water hardness), in medicine as a detoxifying agent for heavy metal poisoning (EDTACAL drug), etc.

Disodium salt of ethylenediaminetetraacetic acid (shortened formula - $\text{Na}_2\text{H}_2\text{Y}$) dissociates in water into an H_2Y^{2-} ion, which reacts with polyvalent cations (Me^{2+} , Me^{3+} or Me^{4+}) in a ratio of 1:1, releasing two protons.

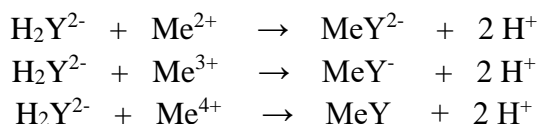

It follows from these equations that only one polyvalent cation is bound in the complex, regardless of its ionic charge. Therefore, the stoichiometric factor of all chelatometric assays is 1.

In order to determine the equivalence point, it is necessary to use a suitable indicator, since both the reagent and even the complexes formed are colourless. So-called metallochromic indicators are used, which are always suitable for a certain group of cations. These indicators are strongly coloured compounds (mostly from the group of azo dyes and sulfophthaleins), which form complexes with cations with different colour from the colour of free indicator. Importantly, the [indicator-metal] complex is less stable than the [complexon-metal] complex. Practically, it means that the solution is coloured with a [indicator-cation] complex at the beginning of the titration. At the end of the titration, there is all metal is bounded in a colourless complex [complexon-cation] and the released indicator results in a colour change. Because the colour of the indicator is pH dependent, it must be titrated in a buffered environment to eliminate the effect of released H^+ ions during the titration.

EDTA disodium salt (Chelaton 3) exists in a very pure state and therefore it is not necessary to standardize it for routine assays. In some special assays, a standard solution of known concentration is prepared and it contains the same cation as the sample. The standard is then titrated with the standard in parallel, it means that the titration of the standard is always performed in addition to the sample (or series of samples). This method is especially selected for the titration using a very dilute EDTA disodium salt (*e.g.* determination of serum calcium). For routine determinations, a titration solution is prepared at a concentration of 0.050 mol / L by dissolving the exact weight in redistilled water and it is stored in plastic containers to prevent unwanted leaching of calcium from the glass.

The recommended indicators are most often murexide (violet in alkaline environment), eriochrome black T (blue in alkaline environment), pyrocatechin violet (red-violet in alkaline environment). For the determination of calcium, fluorexon is recommended, which is pink in strongly alkaline environment, its complex with calcium cations fluoresces yellow-green. The aqueous solutions of the indicators above are not very stable, so they are prepared as solid mixtures with NaCl in a ratio of 1: 100.

The use of this titration method is wide. The most common determinations are:
 Ni^{2+} , Co^{2+} , Cu^{2+} using murexide as indicator,
 Mg^{2+} , Zn^{2+} , Cd^{2+} , Pb^{2+} , Hg^{2+} using Erio T (Eriochrome Black T) as indicator,
 Ni^{2+} , Co^{2+} , Mg^{2+} , Bi^{3+} using pyrocatechin violet as indicator,
 Ca^{2+} using fluorexon as indicator.

Optical methods

Optical methods are one of the most used methods in a biochemical laboratory. These methods are based on an interaction between electromagnetic radiation and material. Optical methods can be divided into spectral and non-spectral.

Spectral methods are based on an exchange between a material and radiation. A material is able to absorb the radiation in a characteristic way (colorimetry, photometry, or spectrophotometry, atomic absorption spectrophotometry) or otherwise to emit the radiation (emission spectral analysis, flame photometry).

Non-spectral methods, there is no exchange of energy but there is just a modification of certain properties of the radiation, *e.g.* change of radiation velocity (refractometry), or rotation of a polarized light plane (polarimetry).

The word optics comes from Greek word *optikós*, it means “regarding to vision”, *óps* means “eye, eyesight” $\delta\phi\theta\alpha\lambda\mu\acute{o}\zeta = \textit{ophthalmos}$ means “eye, eyesight, flash”.

Properties of electromagnetic radiation

The character of electromagnetic radiation is dual. It means that it can be considered as waves of the electromagnetic field and a particle stream called photons.

The electromagnetic radiation is cross-sectional waves and it consists of two components – electrical component (a vector of electric field intensity \vec{E}) and a magnetic component (a vector of magnetic induction \vec{B}). Both components are inextricably linked and they create single electromagnetic field. These components are perpendicular to each other and perpendicular to the direction of wave propagation.

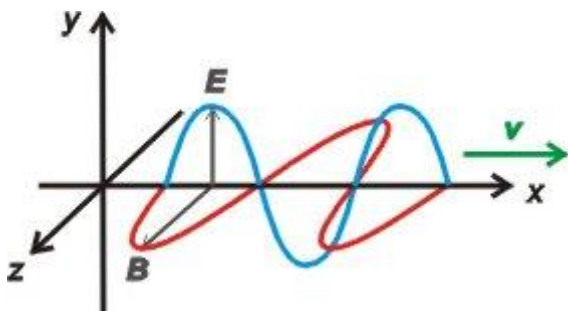

The fundamental of electromagnetic waves was explained by James Clark Maxwell (1831 – 1879, Scottish mathematician and physicist) in the second half of the 19th century.



James Clerk Maxwell

A photon is a quantum of the energy of electromagnetic waves, as a particle has a zero static weight and it moves at the speed of light entirely. The light radiates from the source in wavefronts that are in conformation concentric spherical surfaces. In vacuum, the speed of the light is $c = 299\,792\,458\text{ m}\cdot\text{s}^{-1}$ ($c \approx 3 \times 10^8\text{ m}\cdot\text{s}^{-1} = 300\,000\text{ km}\cdot\text{s}^{-1}$), and it is a maximal speed

that can be achieved by mass subjects. In other environments, there is always the speed of the light lower than in vacuum.

Electromagnetic radiation is characterized by *wavelength* λ , respectively by *frequency* f that determinates its physical properties. The wavelength determinates the colour of the light. Frequency characterized the source of the light and it does not change during the different environment. The relation between frequency and wavelength is defined by the equation:

$$f = \frac{c}{\lambda} \quad [s^{-1} = \text{Hz}]$$

where c ... speed of light
 λ ... wavelength

Energy of the radiation is inversely proportional to wavelength (the smallest distance between two points vibrating in the same phase). It means, the smaller wavelength, the higher photon energy. The photon energy is defined:

$$E = \frac{h \cdot c}{\lambda} = h \cdot f \quad [\text{J}]$$

where h ... Planck constant, 6.6252×10^{-34} J.s
 c ... speed of light in vacuum, 3×10^8 m.s⁻¹
 λ ... wavelength
 f ... frequency

It is possible to distinguish several types of radiation – γ radiation, X radiation, ultraviolet radiation, visible and infrared radiation, microwaves and radio waves. The complex of all electromagnetic radiations arranging in order of increasing wavelength is named the *electromagnetic spectrum* (sometimes named as Maxwell's rainbow). The boundary between particular types of radiation is not sharp, transitions are continuous or some radiations can even overlap.

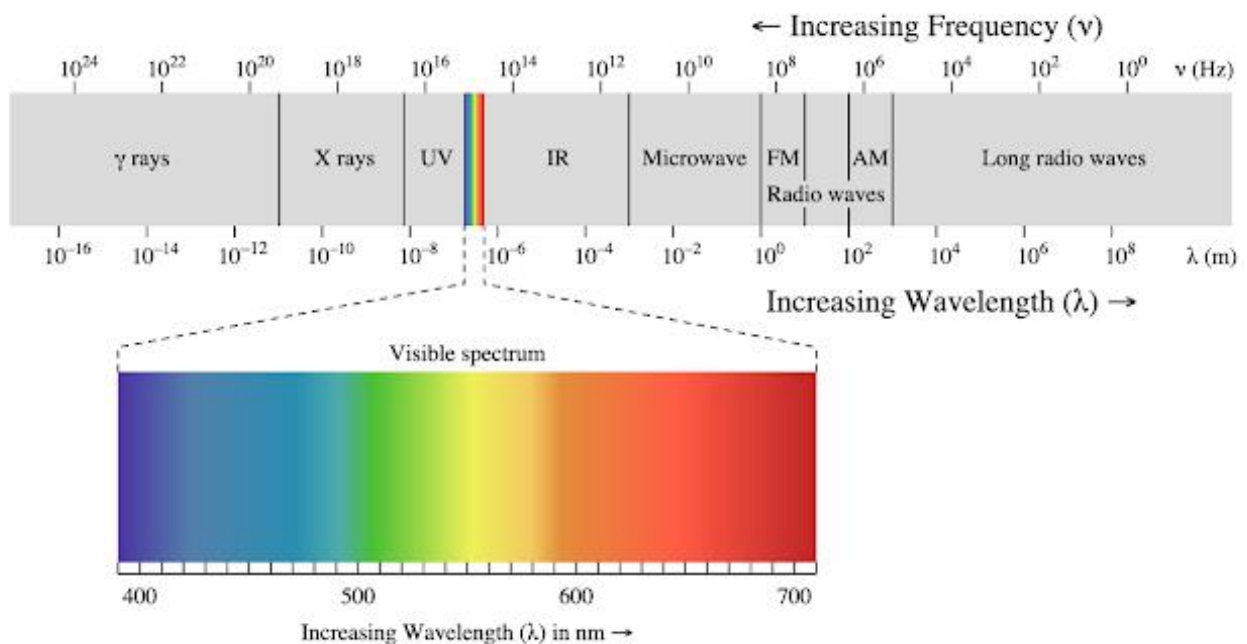

Light is a part of electromagnetic radiation that stimulates retinal photoreceptors in the human eyes. It is a frequency of 8.0×10^{14} Hz to 3.9×10^{14} Hz that corresponds to a wavelength in vacuum from 390 nm to 800 nm. This range is visible light for human. There is different visible range for some kinds of animals, e.g. for bees it is shorter wavelength, ultraviolet radiation, on the other hand for reptiles it is infrared radiation.

Absorption and emission of radiation, colourfulness of substances

In atoms and molecules, there are electrons moving in orbitals, which energies are quantized. If there is a position of the lowest energy, we talk about a basic position. However, there are other energy quantum positions of molecules, so-called excited positions.

An atom or a molecule can absorb only a photon which energy corresponds to the transition among the energy of present positions. If the substance is in the excited state, the photon of the corresponding energy can be emitted and it returns into the basic position. Optical methods are based on these principles.

Substances that do not absorb visible radiation are perceived as colourless. If a substance contains a valence electron that can be excited to a higher energy position and the energy difference between these two positions corresponds to the energy of the wavelength in visible part of the spectrum, the substance is perceived as colour. The colour should correspond to a completing colour to the colour that was absorbed, see the table.

<i>Absorbed wavelength [nm]</i>	<i>The colour of absorbed light</i>	<i>The colour of a substance</i>
350 – 435	violet	yellow-green
435 - 480	blue	yellow
480 - 490	green-blue	orange
490 - 500	blue-green	red
500 - 560	green	purple
560 - 580	yellow-green	violet
580 - 595	yellow	blue
595 - 650	orange	green-blue
650 - 670	red	blue-green

There is possible to assume colouring based on a chemical structure, supposing there is a system of multiple bonds ($-\text{CH}=\text{CH}-\text{CH}=\text{CH}-$), a characteristic functional group (e.g. azo group $-\text{N}=\text{N}-$), complex compounds containing a metal as a central atom or compounds with a transition metal in a high oxidation number. Analytical methods in medical chemistry and biochemistry use this principle, for example a proof of ethanol in breathing air, there is a change of colour in the reduction of Cr^{6+} to Cr^{3+} . The biuret reaction utilizes the formation of a coloured complex in the determination of proteins, etc.

Optical environment can be distinguished according to affect a light propagation:

- 1) **Transparent** – there is no dispersion, a clear environment – all wavelengths pass without any reduction, coloured environment – just a specific wavelength passes, the others are absorbed
- 2) **Translucent** – a part of light is dispersed, there is a deflection (*e.g. dull glass*)
- 3) **Non-transparent** – light is absorbed strongly or there is a reflection of light (*e.g. incidence on a mirror*)

If there are the same characteristics of optical environment in all places, it is a case of **homogenous optical environment**. If there are different characteristics of optical environment in all places, it is a case of **non-homogenous optical environment**.

If the speed of light dispersion is the same in all directions, it is a case of **isotropic** optical environment. If it is an **anisotropic** optical environment, the speed of light dispersion is different and there is its speed dependent on the direction (*e.g. CaCO₃*).

Light dispersion from the source can be:

- 1) **monochromatic light** – it means, light of a certain frequency or narrow frequency range of one particular colour (lat. chromos = colour), this type of light does not occur in nature, the source can be special
- 2) **complex light** – it means, light contains waves of different wavelengths, ordinary light from *e.g.* a light bulb, sun or fluorescent tubes
- 3) **white light** – it is a part of complex light, where only visible radiation is represented

Reflection of light and its refraction

Reflection and **refraction** of light occur at the interface between two optically different environments. Each interface of optical environments is characterized by refractive index.

Absolute refractive index determinates how many times slower light disperses in the environment than in vacuum (refractive index of vacuum is 1, refractive index of other environments is higher).

Relative refractive index states the ratio between speed of light dispersion in two optically different environments.

Refraction index n :

$$n = \frac{c}{v}$$

where c ...speed of light in vacuum ($3 \times 10^8 \text{ m.s}^{-1}$, in one optical environment)
 v ... speed of light in another optical environment [m.s^{-1}]

There are two laws for reflection and refraction of light:

1. Law of light reflection :

The angle of reflection α' is equal to the angle of incidence α and it lies in the plane of incidence.

$$\alpha = \alpha'$$

2. Law of light refraction (Snell's law):

This law determinates relation between the angle of incidence α and the angle of refraction β that lies in the plane of incidence

$$n_2 \cdot \sin \beta = n_1 \cdot \sin \alpha$$

$$\frac{\sin \alpha}{\sin \beta} = \frac{n_2}{n_1} = \frac{v_1}{v_2}$$

where

α ... the angle of incidence

β ... the law of refraction

v_1 ... speed of light in the first environment

v_2 ... speed of light in the second environment

n_1 ... refractive index of light in the first environment

n_2 ... refractive index of light in the second environment

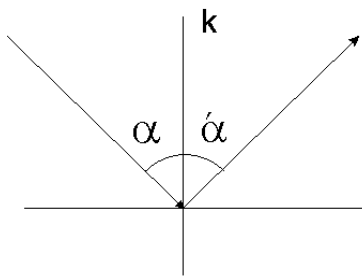

light reflection

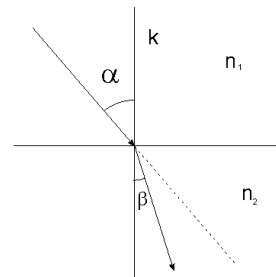

light refraction

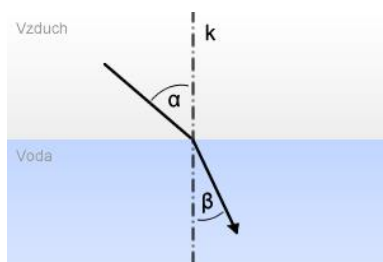

light refraction to perpendicular

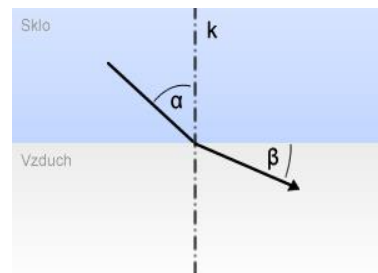

light refraction from perpendicular

In view of the fact that absolute refractive index is dependent on the wavelength of the passing light, white light can be dispersed in particular colours by reflection.

Refractometry utilizes that refractive index of a solution is dependent on its concentration. It was used in clinical practice to determinate relative density of urine or to estimate a concentration of total protein in serum.

Light interference

If there are more waves from different sources, each wave behaves according to *the principle of independence of light dispersion*. It means, each of these waves disperses in the way to be the only one in the environment. In view of this principle, waves reach composition in the point of waves meeting and a *complex wave movement* is created. These waves amplify in a certain point, while they interfere each other in another points. Simplest monochromators (interferential filters) are based on this principle.

Diffraction

Diffraction can occur on any barrier that size is comparable to light wavelength. It can be observed if light passes through a aperture. There is light diffraction and light disperses partially beyond the aperture where it shouldn't disperse (light disperses even into the place of geometric shadow). Considering the fact that there is not sharp boundary between light and shadow, *diffraction pattern* is created. It is a system of unequally wide light and dark stripes. X-ray structure analysis is based on diffraction principle. It is a method is concerned with spatial structure of macromolecules, *e.g.* enzymes or nucleic acids.

In year 1959 the structure of hemoglobine was anlysed by this method.

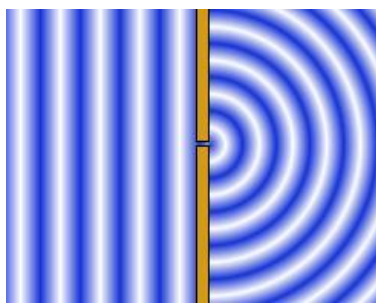

Diffraction on a point aperture

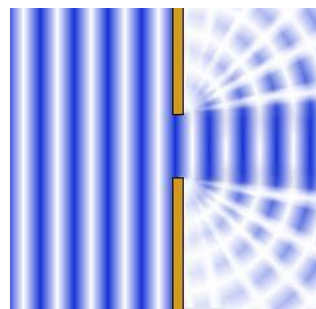

Diffraction on a small aperture

*Light diffraction was observed for the first time by **Francesco Maria Grimaldi** (Italian mathematician) around the year 1660. He let light fall through a small circular opening into a darken room and he placed different subjects into way of this light. He found that shadows were fuzzy and bounded by coloured little stripes.*

Photoelectric effect

Radiation detectors in spectrophotometers work on the basis on this principle of this phenomenon. It is a physical phenomenon so-called photoelectric emission, when photoelectrons are emitted from a substance (mostly from a metal) due to the absorption of electromagnetic radiation. If this phenomenon occurs on a substance surface due to the influence of *external electromagnetic radiation photoelectrons* are emitted into its surroundings, it is an *external photo electric phenomenon*. It is used in solar energy. However, this phenomenon can occur even inside a substance. Emitted photoelectrons do not leave but they stay there as *conductivity electrons* and we named it as an *internal photo electric phenomenon* and it is typical *e.g.* for semi-conductors.

Absorption spectrophotometry

Spectroscopy is a wide branch that examines properties and uses optical spectrums. Depending on if there is investigated emission (generation) or absorption of photons, there are two types of spectroscopy – emission and absorption. Based on the nature of a sample, there can be distinguished spectroscopy atomic and molecular. There is used ultraviolet (UV), visible (VIS), or infrared (IR) radiation for these methods.

Spectroscopic methods are one of the oldest and still the most frequently used instrument of analytic chemistry. Structural analysis as well as concentration can be determined using spectroscopy methods.

History:

Gustav R. Kirchhoff (left) and **Robert W. Bunsen** (right) discovered the foundations of the method of emission spectral analysis in 1859. This method was used for completion of the periodic system, two new alkali metals - cesium (1860) and rubidium (1861) were discovered.



Absorption spectroscopy can be illustrated by the following general scheme:

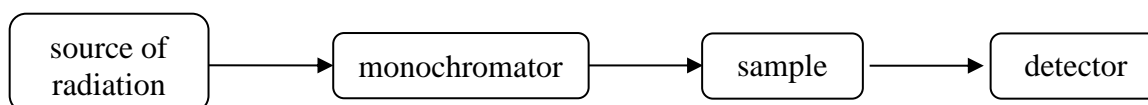

If electromagnetic radiation (light) is absorbed, there is an interaction between the electrical component of the radiation and the electric field of a molecule. The field of the molecule is produced by moving electrons around nuclei of atoms. Electrons move in orbitals and their energy is quantized. If electrons hold the lowest energy position, we say they are in basic position. An existence of another energetic quantum position of the molecule, named as excited positions, is the condition of absorption of light radiation. In other words, if a molecule absorbs light radiation, electrons take higher energy positions and reached excited state and the molecule changes its electron state. The probability of transition is also determined by the amount of absorption.

The probability of transition is determined by the **molar absorption coefficient** ϵ . This coefficient characterizes the structure of a compound and it does not depend on substance concentration. Variation of molar absorption coefficient, or the absorbance, with the wavelength of used radiation is called the absorption spectrum. The absorption spectrum of one substance usually consists of more than one stripe. The individual stripes correspond to certain parts of the molecule structure and they can be separated or they can overlap.

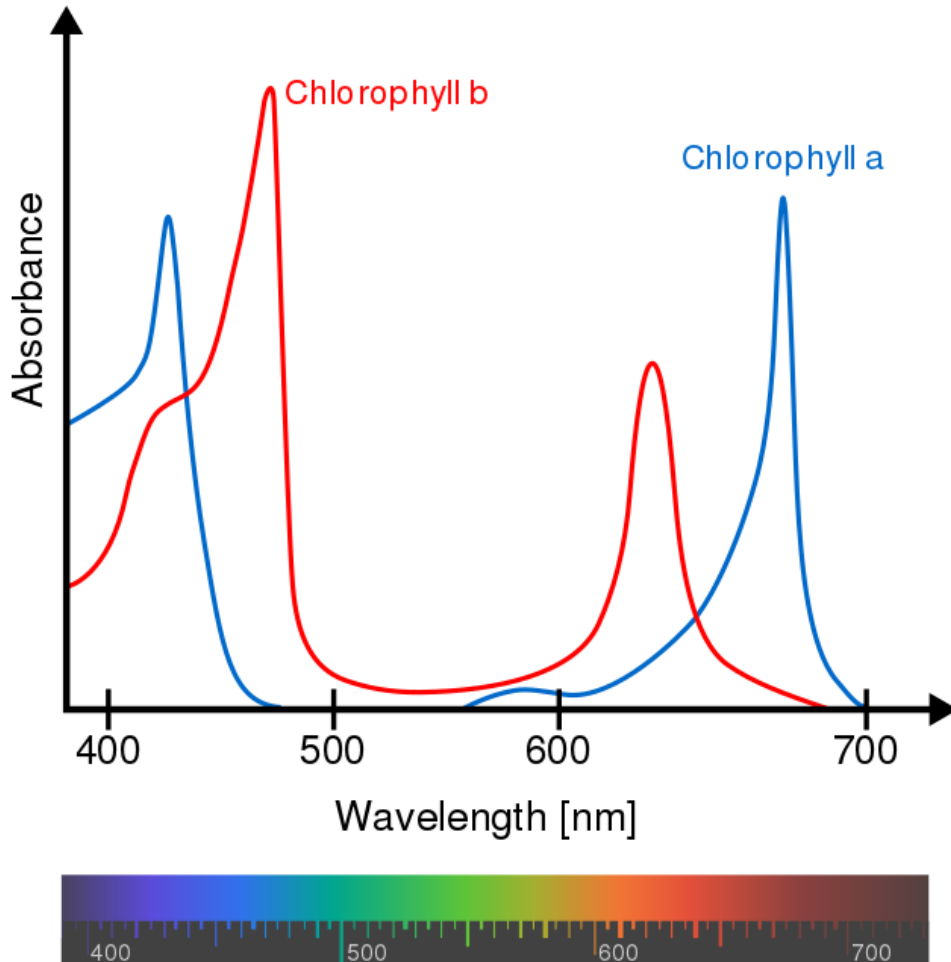

There is a common principle for all absorption methods. We measure the ratio of the intensity of radiation to light up the sample, to the intensity of radiation to pass through the sample. There is establish the quantity of *transmittance T* by:

$$T = \frac{I}{I_0}$$

T...transmittance

I...intensity of radiation to pass through the sample

I₀...intensity of radiation to light up the sample

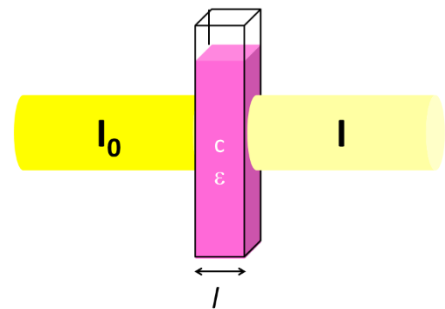

The intensity of radiation to pass through the sample is not only influenced by sample properties but also by absorption and reflection of light on the walls of cuvette and in photometer optics, the measurement environment, etc. And therefore, transmittance is usually measured comparatively in reference to a blank, it is a solution containing all components except the determined component. In practice, there is measured the intensity of light to pass through the blank at first and then the intensity of light to pass through the analysed sample under the same conditions.

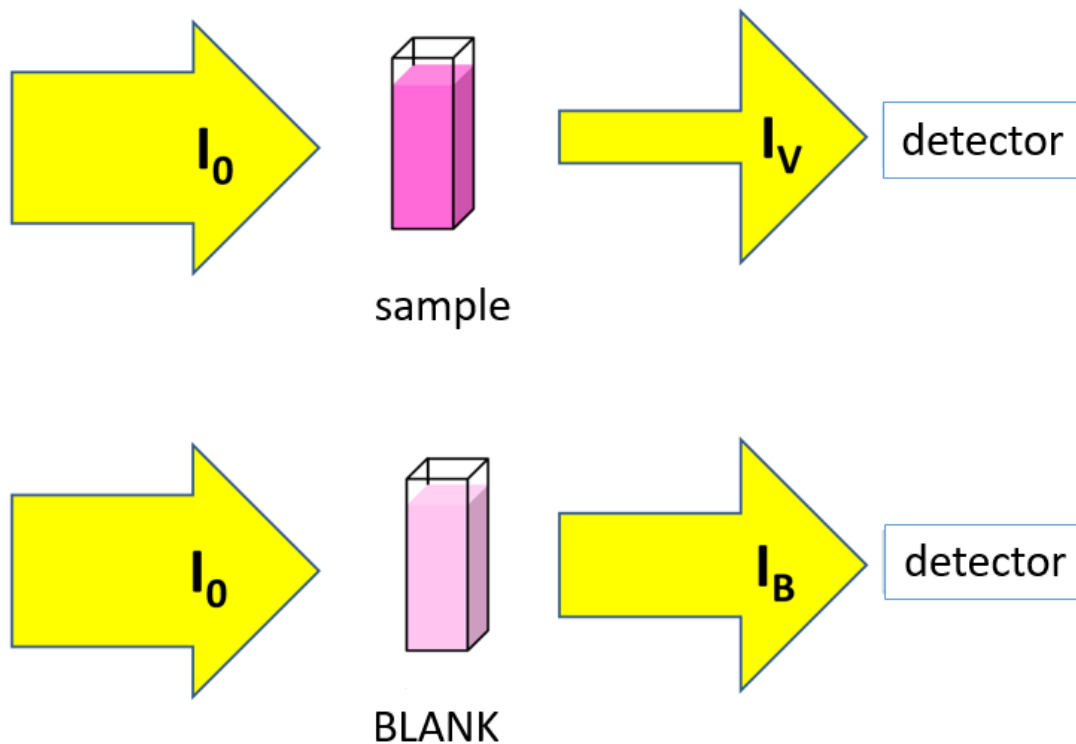

The principle of measuring of absorption spectroscopy

Transmittance is determined:

$$T = \frac{I_V}{I_B}$$

T ... transmittance,

I_V ... intensity of light to pass through the sample

I_B ... intensity of light to pass through the blank

If the transmittance is measured in this way, there is no need to concern non-specific loss of light intensity. The light intensity passing through the blank is considered 100 % (it means, transmittance of the blank is 100 %) and the transmittance of samples absorbing light of a given wavelength is always less than 100 %.

In spectroscopy, there is **absorbance** *A* (extinction *E*, in older literature) utilized more often than transmittance to describe radiation absorption. Absorbance states how much light was absorbed by the sample.

On the basis of transmittance, absorption can be defined as:

$$A = -\log T = \log 1/T$$

A ... absorbance

T ... transmittance of the same sample measured under the same conditions

The definition of transmittance implies relations for absorbance:

$$A = -\log T = -\log \frac{I}{I_0} = \log \frac{I_0}{I}$$

I_0 ... intensity to light up the sample

I ... intensity of light to pass through the sample

The above mentioned, it is evident that zero absorbance corresponds to a sample absorbing any light (it is blank). Absorbance as well as transmittance is a dimensionless quantity.

If the sample absorbs a certain wavelength of visible spectrum (see the middle column of the table), the sample shows as coloured. Other wavelength pass through the sample and the observed colour of the sample is given by a complementary to the absorbed colour (see the column right)

Wavelength (nm)	Absorbed part of VIS spectrum	Complementary colour (= determinates the colour of the sample)
350 - 430	violet	yellow
430 - 475	blue	yellow-orange
475 - 495	green-blue	orange
495 - 505	blue-green	red-orange
505 - 555	green	red
555 - 575	yellow-green	purple
575 - 600	yellow	violet
600 - 650	orange	blue
650 - 700	red	green

The absorbance of the sample depends on:

- Character of the absorbing sample
- Wavelength of transmitted light
- The temperature
- The thickness of the cuvette
- The amount of the absorbing sample

The relation between the absorbance and the concentration of a substance is crucial for utilization spectrophotometry for quantitative analysis. **Lambert-Beer Law** describes the relation between the absorbance and the concentration:

$$A = \varepsilon \cdot c \cdot l ,$$

ε ... molar absorption coefficient [$l \cdot mol^{-1} \cdot cm^{-1}$]

l ... optical path length [cm]

c ... molar concentration of absorbing substance [mol/l]

The law applies to monochromatic light. The advantage is that the absorbance is proportional to the concentration of the absorbing substance. **Molar absorption coefficient** (ϵ) for a given substance is constant that depends on temperature and mainly on wavelength. It is not necessary to determine the value of molar absorption coefficient because the measurement uses a standard of known concentration in parallel or a calibration curves.

August Beer (1825–1863, German physicist, chemist and mathematician who focused on optics mainly) expressed the dependence of transmittance on concentration for the first time. Provided, that there is monochromatic light used, the relation applies:

$$T = 10^{-\epsilon \cdot l \cdot c}$$

T ... transmittance

ϵ ... molar absorption coefficient [$l \cdot \text{mol}^{-1} \cdot \text{cm}^{-1}$]

l ... optical path length [cm]

c ... molar concentration of absorbing substance [mol/l]

There can be obtained the relation using algebraic modifications:

$$\log T = -\epsilon \cdot l \cdot c \quad \text{or} \quad -\log T = \epsilon \cdot l \cdot c$$

The last relation is named as **Lambert-Beer Law** (**Johann Heinrich Lambert**, 1728–1777, Swiss mathematician, physicist, astronomer and philosopher).



Determination of the concentration

Basically, spectrophotometric determination of the concentration can be carried out two ways:

1. Calibration curve method

This method is used when the concentration of samples is occurred in a wide concentration range. The calibration curve is constructed using calibration solution of known concentration. The absorbance of calibration solutions is determined in the same way as the samples. A calibration curve is constructed, the x-axis is the concentration and the y-axis is absorbance.

2. Parallel standard method

This method is useful in case that the concentration of samples is in a particular, relatively narrow range which is common in clinical biochemistry (e.g. analysis of serum, cerebrospinal fluid and other body fluids). The concentration of the standard corresponds to the normal value of a monitored component. Both the standard and samples are measured in the same way and under the same condition and then:

$$A_s = \epsilon \cdot c_s \cdot l$$

$$A_{st} = \epsilon \cdot c_{st} \cdot l$$

$$\text{hence: } \frac{A_s}{A_{st}} = \frac{c_s}{c_{st}} \quad \text{and} \quad c_s = \frac{A_s}{A_{st}} \times c_{st}$$

Spectrophotometer

Photometers and spectrophotometers are used to measure quantities as absorbance and transmittance. A simpler device that measures at a single wavelength or at narrow range of wavelength (it is possible to define by a colour filter), is name as a ***photometer***. Technically more complicated and sophisticated instruments that enable to set a random wavelength are called ***spectrophotometers***.

In principle, the photometer and spectrophotometer consist of four parts:

1. light source
2. monochromator
3. compartment for a sample
4. detector

Principle:

The spectrophotometer consists of a source of white light followed by a monochromator (for example, a diffractive optical grating). It disperses white light into individual components. Radiation of a particular wavelength is selected by a slot. The monochromatic light passes through the sample (in a cuvette) and falls on a detector measuring the intensity of passed light.

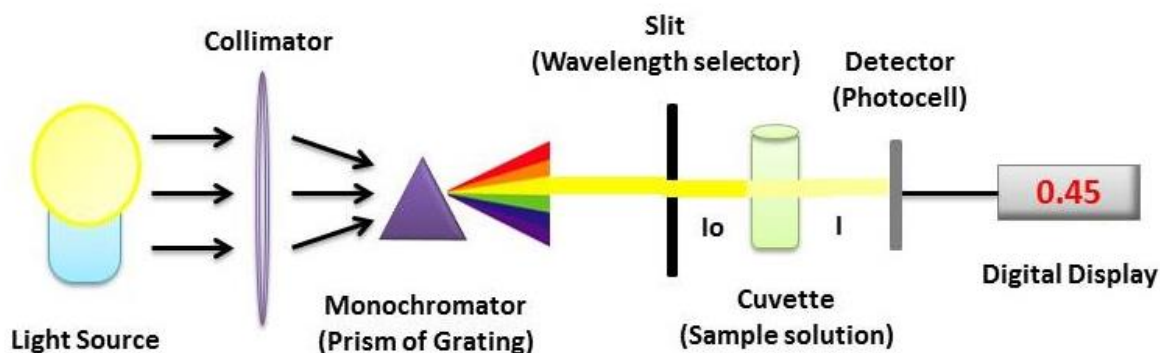

Basic Instrumentation of a Spectrophotometer

Arrangement and function of photometer.

Source of light

A suitable gas tube or bulb are used as a source of light. Bulbs and halogen lamps provide continuous spectrum of radiation in a visible and infrared range, but it cannot be used for measurement in UV range. The most used sources of UV radiation are usually hydrogen or deuterium lamps.

Monochromator

A monochromator is a part that transmits only narrow part of the spectrum of which wavelength can be change. It usually consists of a prism or diffraction grating and of inlet and outlet slot. The simplest and the cheapest is to incorporate a suitable interference filter into the optical path. Simple absorption filters can also be as well as various coloured glasses, coloured metal oxides, or a layers of gelatine between the plates that are mainly used in the visible area.

Sample

Monochromatic light passes through the sample. Usually used solutions are filled into standard cuvettes of 1 cm long optical path (rarely shorter, so-called ultramicro-cuvettes for measuring of a very small volumes of solutions). The cuvettes are placed into the instrument in a space where an exact position is ensured. There can be cuvettes tempered and sometimes can be stirred during the measuring. Some types of instruments insert cuvettes automatically into the optical path and several cuvettes can be measured at the same time. The accuracy of the determination is affected:

- selection of appropriate cuvette – the chosen wavelength should lie in the band the cuvette is intended for
- cleanness of the cuvette – the absorbance must be the same for all cuvettes after filling with distilled water, the cuvette must be dry outside
- homogeneity of the sample – the sample must be mixed enough, there cannot be any bubbles inside (*if there are some bubbles, floating clot or sedimentation, it can usually cause changing absorbance constantly*)
- filled cuvette enough – there used to be a score on the cuvette to determinate the least volume of the sample

If there are measured more samples in one cuvette, the cuvette should be rinsed between samples with distilled water and dried as best as possible. If there are measured similar samples, it is more accurate not to rinse the cuvette with distilled water.

Cuvettes

The cuvettes are made of different materials and can be of different design. Optical glass cuvettes (*OG, G*) are suitable for measuring in the visible part of spectrum. Cuvettes made of quartz glass (*Q, UV*) are suitable for measuring in UV part. Special optical glass cuvettes (*OS*) are also available and they can be used for measuring in a wider part of the spectrum.



Cuvettes

There is a standard internal dimension 1x1cm and a height of 3 – 4 cm of cuvettes. According to the type of photometer, the cuvettes are usually filled to volume of approx. 3 ml. If there are used constricted cuvettes, much smaller volumes (hundreds microliters) can be measured.

Another types of cuvettes are used for special application, e.g. flow cuvettes, tempered cuvettes, spectrophotometric capillary etc. Lately, photometers with built-in cuvettes are used and the sample volume of 1 μ l can be measured (*e.g. measuring of concentration of isolated DNA, just a limited amount of a sample is available*).

Detectors

Light leaving the sample falls on the detector. It is usually a photodiode or other photoelectric element. Final absorbance is obtained by comparing the radiation intensity passing through the sample and the radiation intensity passing through the reference solution. If a ***single-beam*** photometer is used, the blank is measured at first and then the sample is measured. If the photometer is ***double-beam***, there are two detectors and the blank and the sample can be measured at the same time.

Absorption photometry is used for determination of the solution of colourless as well as coloured solutions. Colourless solutions are measured at UV light (200 – 380nm), coloured solutions are measured at both UV and visible light (380 – 760nm).

Determinative criterion for selecting the wavelength is as the highest as possible the sensitivity of measurement. The wavelength of the absorption maximum corresponds to this requirement.

Flame photometry

It is the type of emission spectroscopy, *flame atomic emission spectroscopy (FAES)*. It can also be used for determination of concentration of sodium, potassium, lithium ions, or calcium and cesium in biological fluids. For the same purpose, today measurements using ion-selective electrodes or photometry of chemically formed coloured complex of these ions are more commonly used in clinical laboratories.

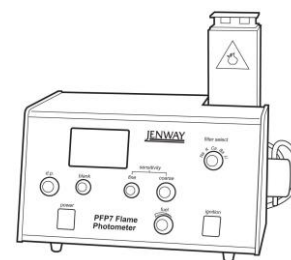

Flame photometry is an analytic method of optical emission spectrometry (OES). It deals with examining and utilization of radiation emitted by free excited atoms or element ions in gaseous state. The basic parts of the optical emission spectrometer are:

- excitation source – a source of energy needed to induce radiation emission of the sample atoms,
- monochromator,
- detector.

The analytical output is an emission line spectrum where the position of the line specifies the qualitative composition of the sample and the intensity of the line determines the amount of the sample.

Flame photometry is used to determine the content of elements 1st and 2nd A group of the periodic table due to no too high energy required to excite their valence electrons and the flame temperature is sufficient for it. Some alkali and alkaline earth metals colour the flame characteristically. Lithium stains the flame red, sodium yellow, potassium violet, calcium brick red and cesium blue-violet. The intensity of the flame colouring is proportional to the concentration of ions in the sample.

The samples are delivered to the flame as an aerosol. The valence electrons are excited by the heat and take a higher energy position for a fraction of a second. In a colder part of the flame, these electrons return to the original position and they emit light which wavelength is characteristic of each element. The emission spectra are linear and occur in the visible range of the spectrum.



Enzymology

Introduction to enzymology

Virtually all the biologically important reactions are catalysed. This is achieved with the help of specific biocatalysts known as *enzymes*. The enzymes are able to increase the rate of reactions that may occur in the particular cell or tissue. It should be noted that enzymes do not change the chemical equilibrium neither total energy input or output of the reaction. *Enzymes increase reaction rates by decreasing the activation barrier of the reaction.*

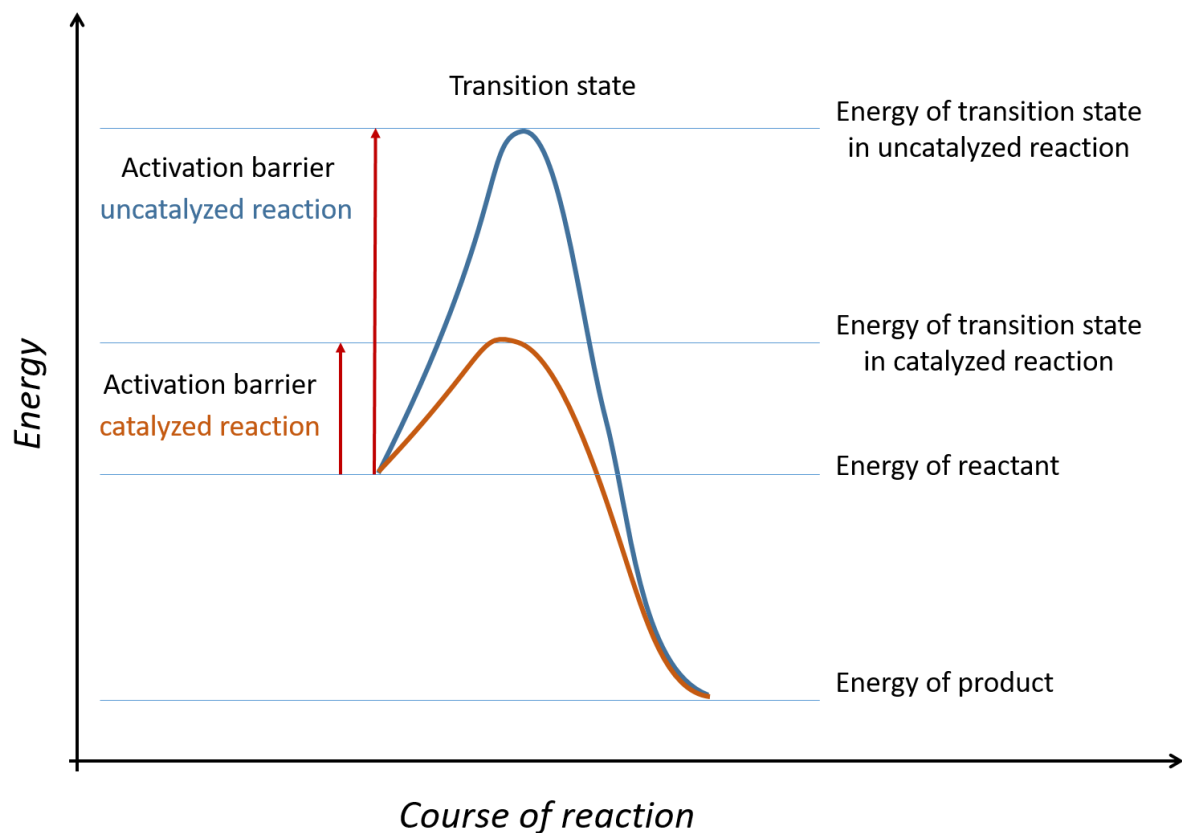

Almost all known enzymes are *proteins*. The molecular weights of enzymes cover a wide range. For example, the enzyme ribonuclease is relatively small, having molecular weight approximately 13,700. In contrast, aldolase, an enzyme of glycolysis, has a molecular weight of approximately 156,600. It is composed of four subunits, each with a molecular weight of about 40,000. Pyruvate dehydrogenase, which catalyses the conversion of pyruvate to acetyl-coenzyme A, is a multi-enzyme complex in which the components are so tightly organised that the entire system can be isolated as a discrete, particulate entity from many tissues. The complex from pig heart has a molecular weight of about 1×10^7 . Each complex contains no fewer than 42 individual molecules, including several important and essential cofactors. The entire structure of the pyruvate dehydrogenase complex is required for catalysis.

In addition to the protein component, many enzymes require non-protein constituents for their function as catalysts. These accessory moieties are variously termed prosthetic group, cofactor, and coenzyme. The term *prosthetic group* applies to any non-amino acid portion of an enzyme that confers on that enzyme some particular property. Prosthetic groups are connected to the protein part either covalently (hem in cytochromes) or non-covalently (hem in haemoglobin). The term *cofactor* is also broadly defined. Small organic molecules such as phospholipids are essential to maintain certain enzyme proteins in a conformation suitable for catalysis (β -hydroxybutyrate dehydrogenase), even though they do not directly participate in the catalytic event. Some enzymes require a cation (e.g. magnesium) or less often an anion (e.g. chloride) as a cofactor. Enzymes that require a metallic ion to be present within the protein structure for their function form the family known as *metalloenzymes* (e.g. carbonic anhydrase contains a zinc atom in each molecule). The term *coenzyme* applies to organic molecules, often but not always derived from a vitamin, which are essential for activity of numerous enzymes. Some coenzymes are tightly bound to the protein portion of a given enzyme; indeed, the enzyme may be denatured when attempts are made to remove the coenzyme. In other instances the coenzyme is bound so loosely that simple dialysis will separate it from its protein partner. Coenzymes always participate in the catalytic reaction. The complete functional complex of protein plus all required accessory factors of any kind are known as the *holoenzyme*; the protein part, free of cofactors, is termed an *apoenzyme*.

Probably the most striking property of enzymes is their specificity, even if it is not always absolute. Urease or catalase are the examples of enzymes with absolute specificity towards their substrates, chymotrypsin on the other hand shows a somewhat lesser specificity, it prefers to cleave peptide bonds in which one participant amino acid has an aromatic ring.

Enzymes isolated from their natural sources can be used in vitro to study in detail the reaction they catalyse. Reaction rates may be altered by varying such parameters as pH or temperature, by changing the ionic composition of the medium, or by changing ligands other than the substrate or coenzymes.

Since protein structure determines enzyme activity, anything that disturbs this structure may lead to change in activity. Denaturation of proteins, which means the spatially random arrangement, can be produced by many agents. These include heat and chemicals that destroy hydrogen bonds in the protein, such as urea at high concentration, detergents such as sodium dodecyl sulfate, and sulfhydryl reagents such as mercaptoethanol. Enzymes frequently show great thermal sensitivity. When heated to temperatures greater than 50°C, most but not all (e.g. enzymes of thermophilic bacteria) enzymes are denatured. High-temperature denaturation is usually irreversible.

In general, the rate of a chemical reaction increases with increasing temperature (a temperature increase of 10°C will approximately double the rate). In the case of enzyme reactions, however, this only applies to a certain extent - until the denaturation leading to a reduction in the reaction rate prevails. Most enzymes show a certain *temperature optimum* at which the activity is maximal. The changes in activity above and below the temperature optimum are not always symmetric.

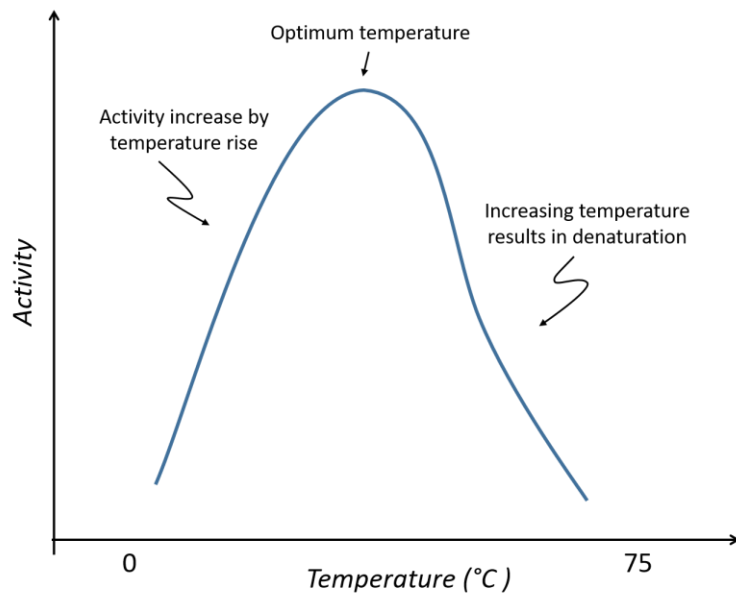

Enzyme activity is also related to the ionic state of the molecule and especially of the protein part, since the polypeptide chains contain groups that can ionize to a degree that depends on the prevailing pH. As is true of proteins generally, enzymes have an *isoelectric point* at which their net free charge is zero. The pH of the isoelectric point (pI) as a rule is not the same as the pH at which maximal activity is demonstrated. The *pH optima* shown by enzymes vary widely. Pepsin, which exists in the acid environment of the stomach, has a pH optimum at about 1.5, whereas arginase, an enzyme that cleaves the amino acid arginine, has its optimum at 9.7. However, most enzymes have optima that fall between pH 4 and 8. Some enzymes show a wide tolerance for pH changes, but others work well only in a narrow range. If any enzyme is exposed to extreme values of pH, it is denatured. The sensitivity of enzymes to altered pH is one reason why regulation of body pH is so closely controlled and why changes from normal may involve serious consequences.

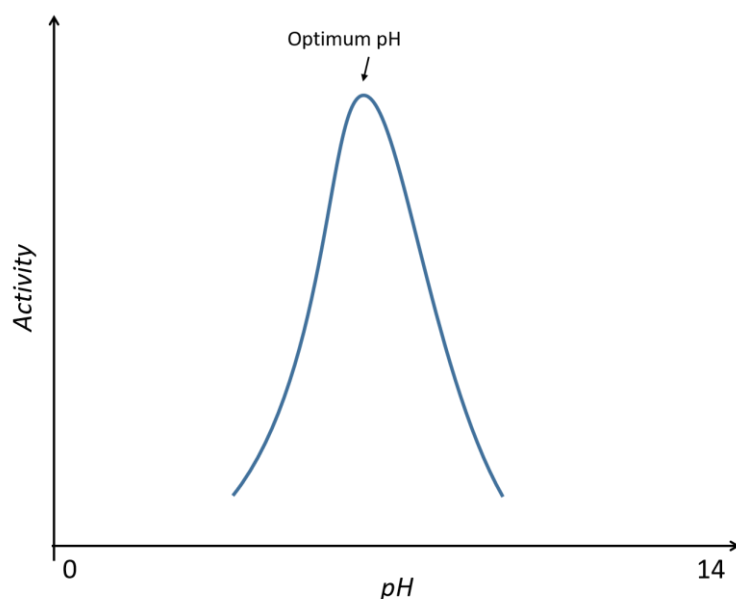

Enzymes differ from other proteins in that they possess what has been termed as *active catalytic site*. The active site can be regarded as being composed of a relatively small number of amino acid residues, not necessarily in immediate sequence in terms of primary structure. However, these amino acids interact in a manner that allows catalysis to occur. Because of the peculiar and highly individualized ways in which peptide chains may be folded, amino acids some distance apart in the primary structure may contribute to the active site. At the same time, if some molecular change occurs, the necessary interaction of amino acids composing the active site probably will be weakened or lost. This accounts for relatively mild treatment possibly causing denaturation.

Some enzymes, namely those with strong irreversible effects (e.g. proteolytic enzymes of digestive tract, enzymes of blood clotting cascade, etc.) are synthesized as inactive precursors also named *proenzymes* or *zymogens*. Typical activation mechanism is the excision of a peptide fragment followed by a change of conformation and a formation of the active site.

In many species, including human, different molecular forms of certain enzymes may be isolated from the same or different tissues. The different molecular forms have been termed *isoenzymes* or *isozymes*. Lactate dehydrogenase (LDH) and malate dehydrogenase have been thoroughly studied as examples of isoenzymes. LDH is composed of four subunits. The two subunit types, differing in amino acid content and sequence, can be combined into tetramers in five ways. If one subunit type is identified as “M” (the major form found in muscle or liver) and the second as “H” (the major form found in heart), the tetramers could have compositions M_4 , M_3H , M_2H_2 , MH_3 and H_4 . These can be separated by electrophoresis. In humans the content of several isoenzymes differs in heart and liver, and this difference was used in the past in diagnostic differentiation of diseases of the liver and myocardium.

A unit of enzymatic activity is the katal (kat) which is defined as the moles of substrate transformed per second. Enzyme concentrations in the analyzed body fluids (serum, cerebrospinal fluid, urine, etc.) are expressed as kat/L (mkat/L, μ kat/L, etc.)

When determining the activity, we usually measure the decrease of the substrate or the increase of the product. It is also possible to measure coenzyme changes, i.e. anything that is convenient from a laboratory point of view. Various synthetic substrates yielding coloured products, or even subsequent reactions based on the properties of by-products of the enzyme reaction, have proven themselves.

Enzyme kinetics

It was mentioned above that enzymes increase the reaction rate by their catalytic action. Let us explain some quantitative aspects of enzyme reaction kinetics. The quantitative analysis of enzyme action depends largely on measured reaction times. If the initial reaction rate, defined as the rate observed for a given amount of enzyme when the concentration of product formed is nearly zero, is plotted as a function of the substrate concentration, the results appear similar to those shown below:

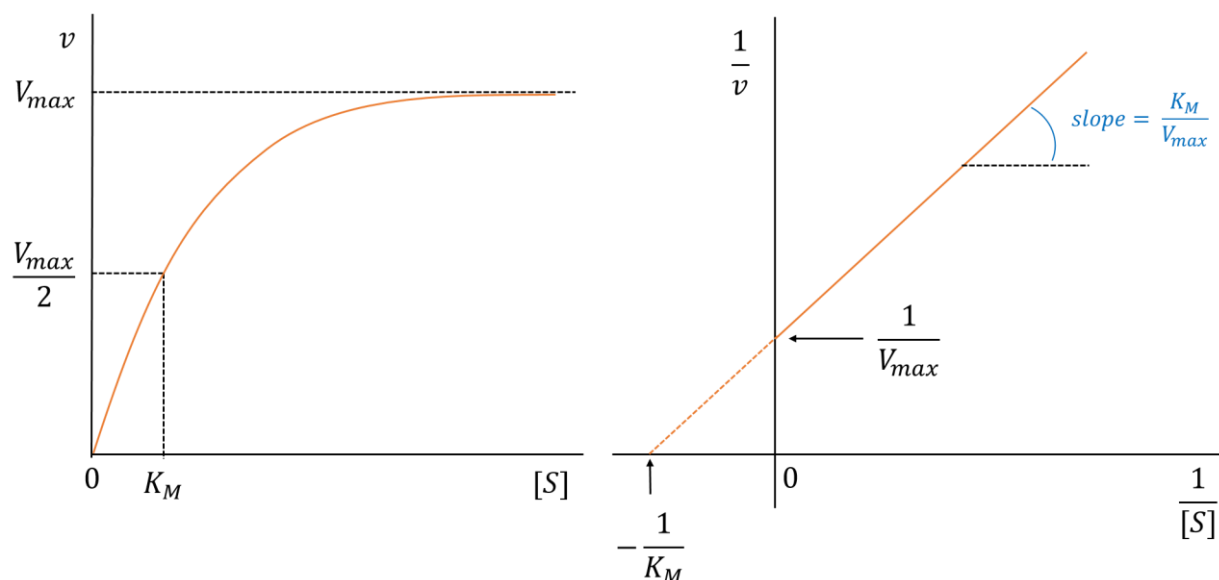

The curve connecting the observed points would be a hyperbola and would asymptotically approach a maximum value, as shown by V_{max} . This is the maximum initial velocity that can be obtained without increasing the amount of enzyme.

The hyperbola described by a plot of reaction velocities as a function of substrate concentrations is difficult to use. If reciprocals of the velocities are plotted as a function of the reciprocal substrate concentrations, the hyperbola is converted to a straight line. The double-reciprocal plots are frequently called Lineweaver-Burk plot.

If the usual convention is followed, representing concentrations by means of brackets, that is, by letting $[S]$ stand for the molar concentration of the substrate, and if a few assumptions are made regarding the experimental situation, one can obtain a useful mathematical equation that describes the enzyme kinetics.

Assume for the present that:

1. The system involves only a single substrate S.
2. The system is at steady state, that is, $[ES]$ is a constant and the free enzyme E is in equilibrium with complex enzyme-substrate ES.
3. The system is established so that $[E] < [S]$ on a molar basis.
4. Since the analysis deal with initial reaction rates (i.e. almost no product P is formed yet), $[S] \gg [P]$ and $[P]$ is negligible under these conditions.

The reaction mechanism of such a single-substrate reaction may be formulated as follows:



where k_1 , k_2 , k_3 , and k_4 are the respective rate constants.

At the steady state the concentration of ES is constant; that is, the rate at which it is being formed is the same as the rate at which it is being broken down. Under these conditions the rate equation can be derived:

$$k_1[E][S] + k_4[E][P] = k_2[ES] + k_3[ES]$$

rate of ES formation rate of ES dissociation

Since the analysis is restricted to initial reaction rates, [P] is negligible and [S] is virtually constant. Thus the term involving [P] can be dropped and those involving [ES] can be collected to give the following:

$$k_1[E][S] = (k_2 + k_3)[ES] \quad \text{or}$$

$$\frac{[E][S]}{[ES]} = \frac{k_2 + k_3}{k_1} = K_M$$

The ratio of rate constants can be replaced by a single constant, K_M , known as *Michaelis constant*.

If in the reaction mechanism, which consists of a sequence of several reactions, one is significantly slower, then the reaction rate of this reaction determines the resulting reaction rate of the entire reaction mechanism. Here, the formation of the product is a decisive step. The observed initial velocity will be the following:

$$v = k_3 [ES]$$

The enzyme present is either free or bound in a complex with substrate. Only the total enzyme concentration $[E]_0$ is accessible for measurement.

$$[E]_0 = [E] + [ES]$$

Combining the above mentioned equations yields:

$$\frac{([E]_0 - [ES])[S]}{[ES]} = \frac{k_2 + k_3}{k_1} = K_M$$

$$[ES] = \frac{[E]_0[S]}{\frac{k_2 + k_3}{k_1} + [S]}$$

The observed initial velocity is then the following function:

$$v = k_3 \frac{[E]_0[S]}{\frac{k_2 + k_3}{k_1} + [S]}$$

The maximum initial velocity is achieved only when all the enzyme is in the form of the active complex ES, from which it follows that:

$$V_{max} = k_3 [E]_0$$

For a given enzyme concentration, the maximum initial velocity is constant.

Using the above constants, the final version of **Michaelis-Menten equation** can be derived:

$$v = \frac{V_{max}[S]}{K_M + [S]}$$

A significance of K_M is seen from this equation. When it is equal to concentration of substrate ($K_M = [S]$), then $v = \frac{1}{2} V_{max}$. This relation is actually the definition of K_M :

The Michaelis constant is the substrate concentration at which the initial reaction velocity is equal to half maximal. Both, K_M and $[S]$ are expressed in the same units, moles per litre - mol/L.

Also, when $[S]$ is significantly higher than K_M , K_M can be dropped to yield:

$$v = V_{max} = k_3 [E]_0$$

On the other hand, if $[S]$ is negligibly low compared to K_M , then:

$$v = \frac{V_{max}[S]}{K_M}$$

These relations should be followed in any laboratory reaction. In designing any assay to measure the amount of an enzyme in blood or other material, it is important to ensure that sufficient substrate is present to saturate the enzyme completely, that is, to convert it entirely to the enzyme-substrate complex (the reaction rate in this case depends only on the concentration of the enzyme, it does not depend on the concentration of the substrate). On the other hand, when substrate is measured in enzymatic reaction, the relative excess of enzyme is necessary to have the reaction rate to be a function of substrate concentration.

The significance of K_M in metabolism centres its operational definition as the concentration of substrate at which the initial velocity is half its maximum. From this, some important points can be made:

1. The concentration of substrate *in vivo* will play a role in the rate of the conversion to product only if its concentration approximates the K_M .
2. If an enzyme has two or more substrates that can be converted to their respective products, each substrate having its K_M and V_{max} , the rates of conversion of each substrate can be calculated from the Michaelis-Menten equation. This calculation requires that the *in vivo* concentration of each substrate is known. If the *in vivo* concentration is much less than the K_M , that substrate will not be significantly converted to product. An example is the alcohol dehydrogenase which “prefers” ethanol to other alcohols.

3. If a substrate can be converted to a product by either two enzymes, the enzyme with the lower K_M will convert the majority of the substrate to its specific product. The physiological importance of the reaction can be predicted, using K_M , V_{max} and the *in vivo* concentration of the substrate.

Inhibition and regulation of enzyme activity

Enzymes can be inhibited by specific molecules or ions. In irreversible inhibition, the inhibitor is bound covalently to the enzyme or is otherwise attached so tightly that dissociation of the inhibitor from the enzyme is very low. Reversible inhibition, on the other hand, is characterized by a true equilibrium between the free enzyme and the inhibitor and the enzyme-inhibitor complex. Competitive inhibitors prevent the substrate from binding to the active site. They decrease the reaction rate by reducing the number of enzyme molecules that bind the substrate. Non-competitive inhibitors, on the other hand, reduce the turnover number. Distinguishing between the two types of inhibition is possible by determining whether the inhibition can be suppressed by increased substrate concentration, which is typical for competitive inhibition.

The activity of many enzymes is tightly regulated *in vivo*. In this regard, so-called allosteric interactions, which are interactions between spatially different sites of enzymes, are important. In enzyme regulation, we very often encounter a phenomenon in which the end product of a biosynthetic pathway inhibits the enzyme catalysing the reaction near the beginning of this pathway (= **feedback inhibition**). Enzymes are also often controlled by regulatory proteins of the calmodulin type, whose conformation reflects the level of calcium ions. Covalent modification through phosphorylation of serine, tyrosine or threonine residues in the enzyme structure is also an important tool for enzyme regulation. The most powerful regulatory mechanism is probably associated with the formation of inactive precursors, which are transformed into active enzymes by proteolytic cleavage - the so-called **proteolytic activation**.

The principal of enzyme catalysis is usually the selective stabilization of an activated intermediate, which is bound by the enzyme more tightly than the original substrate. That is why structural analogues of activated intermediates are the most effective enzyme inhibitors. This also applies to immunogens, since the interaction of antigen with antibody strongly resembles an enzyme-substrate reaction, and the best producers of antibodies are immunogens (antigens) that mimic an activated intermediate.

Lineweaver-Burk plots can be used to assess the nature of enzyme inhibition. If catalysis is to occur, a certain structural correlation must exist between the substrate on the one hand and the active site of the enzyme and the surroundings on the other. Anything that alters or interferes with this "fit" will inhibit or prevent catalysis. Metabolites, drugs, or toxic substances may inhibit enzymes so that normal catalysed reaction occurs at a lower rate, if at all. The inhibitors may be classified according to how they react with the enzyme:

Competitive inhibitors bind reversibly with the enzyme in competitions with the substrate. When the inhibitor is bound to the enzyme, the normal substrate cannot form the ES active complex, and thus less enzyme is available for catalysis. Since the competition for the enzyme is proportionate to the concentrations of the substrate and the inhibitor, a sufficient concentration of the substrate will overwhelm the inhibition, and the V_{max} will be the same as with no inhibitor present. At concentrations in which substrate and inhibitor are more comparable, the K_M for the substrate will be increased.

Competitive inhibition depicted by Lineweaver-Burk plots. A, Normal uninhibited reaction. B and C, Two different inhibitor concentrations ($B < C$).

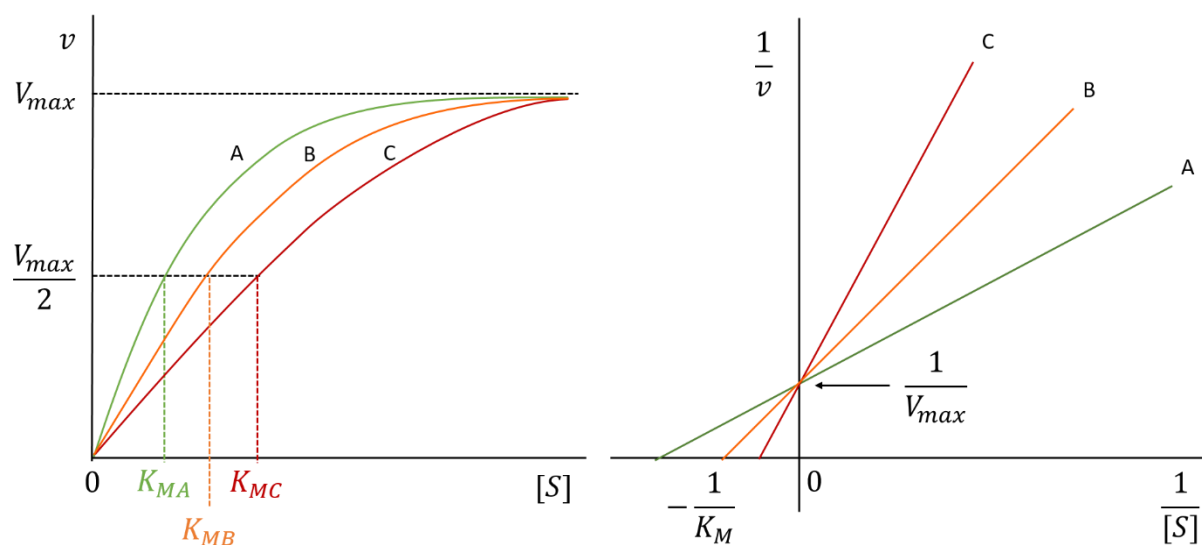

Noncompetitive inhibitors bind either to the enzyme or the enzyme-substrate complex. In this case the V_{max} is decreased without the change in the K_M for the substrate. Even an extremely high substrate concentration cannot completely eliminate the inhibitory effect.

Noncompetitive inhibition depicted by Lineweaver-Burk plots. A, Normal uninhibited reaction. B and C, Two different inhibitor concentrations ($B < C$).

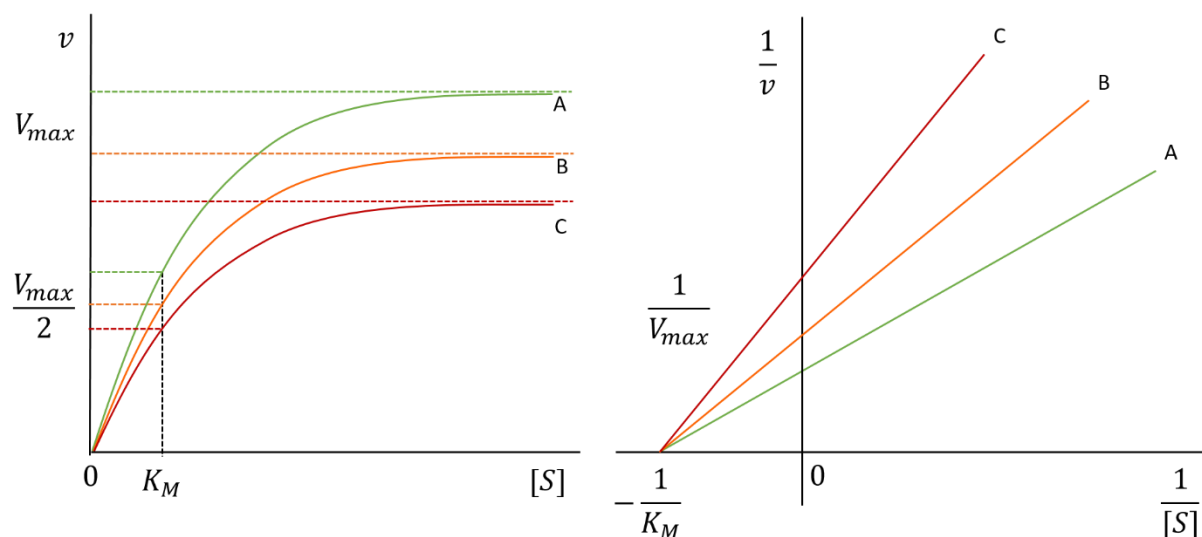

Some enzymes do not follow the kinetics of the Michaelis-Menten model. A significant group of such enzymes are subject to control by molecules that bind to sites on the enzyme other than the catalytic site. Such molecules, called *effectors*, influence the binding of the substrate to the catalytic site. These enzymes are known as *allosteric enzymes*. Some allosteric enzymes are composed of subunits of identical or closely related peptide chains. The quaternary conformation is modified by the appropriate allosteric effectors. One or more of functional sites on these enzymes may be catalytic, whereas one or more other sites may be regulatory and not identical with the catalytic or active sites. In some instances regulatory and catalytic sites are on different subunits; in other instances regulatory and catalytic sites are located on the same subunit. When the reaction velocity of an allosteric enzyme is plotted as a function of substrate concentration, a sigmoid rather than hyperbolic curve is obtained. One can see that the shapes of the allosteric curves are changed considerably by altering the concentration of either positive or negative effectors. In effect, decreasing the amount of negative effector or increasing the amount of positive effector produces a response equivalent to lowering the K_M of the substrate. In the most general case allosteric kinetics can be represented by the following equation:

$$v = \frac{V_{max}[S]^n}{K + [S]^n}$$

where n is a coefficient that represents the interaction of the binding site, K represents a measure of the affinity of substrate for enzyme (other symbols have their previously stated meaning).

Allosteric enzymes composed of multiple subunits often show a *cooperative effect*. The binding of the first substrate molecule to the enzyme will affect the conformation of the other active sites and change the affinity of the enzyme for other substrate molecules. Therefore, in a certain range of substrate concentrations, a minimal change in substrate concentration will cause a significant change in the reaction rate, much larger compared to a classical enzyme. This effect guarantees the maintenance of the substrate level within a certain range.

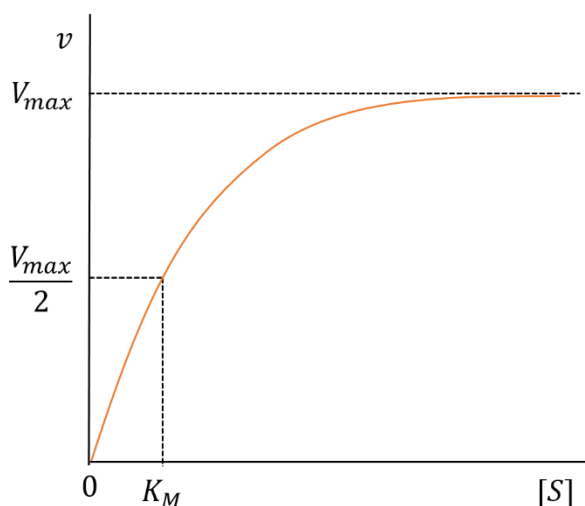

Michaelis-Menten kinetics

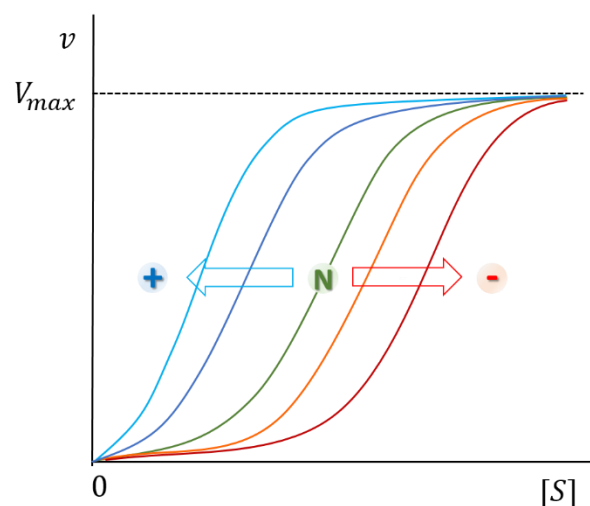

Allosteric kinetics

Catalase and reactive oxygen species

Erythrocyte catalase is part of a system that breaks down unwanted reactive oxygen species or their products.

Molecular oxygen is a biradical that has two unpaired electrons. These two electrons have the same quantum spin number (parallel spin) and require incoming electrons to be also of parallel spin so as to fit into the vacant spaces in the p orbitals. In accordance with Pauli's exclusion principle, a pair of electrons from an atomic or molecular orbital would have antiparallel spins. These conditions impose restrictions involving spin inversions on oxidations by O₂ that tend to make it accept its electrons one at a time. The advantage of this process for aerobic life is a considerable slowing down of reactions of oxygen with non-radicals. The disadvantage, however, is that one-electron reduction of O₂ leads to the formation of reactive oxygen species.

Free radicals can be defined as molecules, atoms or ions, capable of independent existence that contain at least one **unpaired electron**. Free radicals may be created in a number of ways:

- 1) *homolytic bond cleavage*
- 2) *single-electron reduction*, *i.e.* by adding one electron
- 3) *single-electron oxidation*, *i.e.* by losing one electron

Chemical reactions involving free radicals are usually **chain reactions** with an initiation, a propagation and a termination step. Because of the propagation phase of the chain reaction, free radicals have the potential to be extremely harmful to biomolecules (including DNA, proteins, and the lipids of cell membranes). Once a free radical is generated, it can react with stable molecules to form new free radicals from them. These new free radicals go on to generate new free radicals, and so on.

Not only exogenous factors, such as UV or X-rays, smoking or intoxication, contribute to the formation of free radicals in the body, but also the formation of free radicals is a common part of metabolism. One of the processes where large amounts of free radicals occur in the cell is the respiratory chain in the mitochondria.

However, free radicals cannot be seen only as a source of damage to biomolecules, cell structures, cells and whole tissues. Free radicals also perform a number of important physiological functions. For example, phagocytes use free radicals to kill microorganisms (they are equipped with the enzymes NADPH oxidase, which produces superoxide, and myeloperoxidase, which catalyzes the synthesis of hypochlorous acid). In addition, they can perform a signalling function, such as nitric oxide, which acts as a local mediator. Or they are used in biosynthesis (e.g. cyclooxygenase-produced superoxide radical in prostaglandin biosynthesis, hydroxylation catalyzed by monooxygenases).

One electron reduction product of O₂ is the superoxide radical (anion) O₂^{•-}

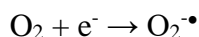

Its protonated form is the hydroperoxyl radical HO₂[•]. The pK_a for its dissociation is approximately 4.8, there is likely to be little present at physiological pH and the superoxide anion, therefore, is the main one-electron reduction product of dioxygen in aqueous biological media.



Generation of O₂^{•-} in solution has been observed to kill or inactivate bacteria and other cells, stimulate lipid peroxidation, and damage DNA, carbohydrates, and proteins. Chemical studies, however, cast considerable doubt on this, for in aqueous solutions O₂^{•-} is a weak oxidizing agent and moderately strong reducing agent. Most, if not all, damage associated with the generating of O₂^{•-} must be due to other species whose formation depends on it. The hydroperoxyl radical has a greater oxidizing potential than O₂^{•-} and may be important at sites with an acid pH or within the lipophilic membrane interior.

The major reaction of O₂^{•-} is the dismutation reaction, which take place in two stages:

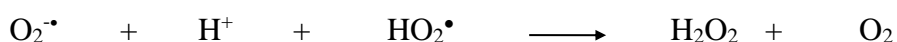

Overall reaction:

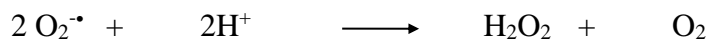

Since the concentration of H⁺ is low at physiological pH the spontaneous dismutation reaction is slow, allowing O₂^{•-} to diffuse from its site of formation. To prevent this, most of the aerobic organisms contain *superoxide dismutase*, an enzyme which is able to speed up the above reaction. It is usually combined with the action of *catalase*, which completes the oxygen radical detoxification process by disproportionating the H₂O₂ to H₂O and O₂:

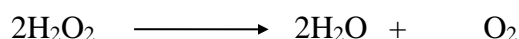

Another enzyme present in erythrocytes, *glutathione peroxidase*, removes hydrogen peroxide by another mechanism, using reduced glutathione (GSH):

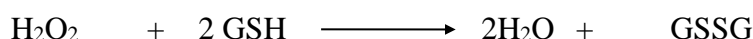

Hydrogen peroxide H₂O₂ is the two electron reduction product of O₂ and since it has no unpaired electrons it cannot be called a radical. It is the most stable of the intermediates formed in the reduction of O₂ to water. It thus can diffuse from its site of formation and can also cross cell membranes, unlike O₂^{•-}, which does not cross membranes unless there is a specific channel for it.

Addition of an electron to hydrogen peroxide gives the hydroxyl radical OH• and hydroxyl anion:

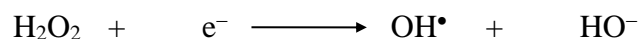

This is a highly active and most dangerous species reacting at a near diffusion controlled rate with almost any biological molecule, Therefore, it cannot move far from its site of generation. Hydroxyl radicals react by several mechanisms, the most important being the hydrogen abstraction, which is also the basis of lipid peroxidation. The chemists suggested that O_2^\bullet and H_2O_2 can directly react to give OH• (Haber-Weiss reaction). However, it was soon clear that this reaction was not biologically feasible but could occur through metal ion catalysis (Fenton reaction). Participation of trace amounts of iron salts in the reaction is essential and, therefore, non-bound iron or other metal ions are considered as dangerous.

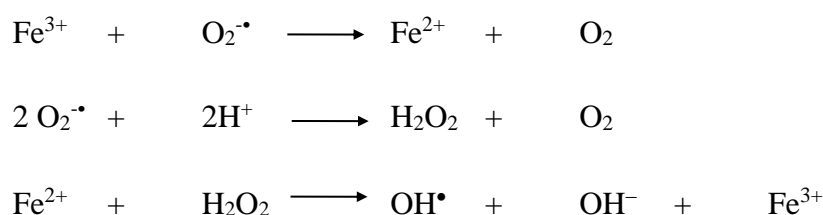

A highly susceptible target for the action of oxygen radicals is the polyunsaturated fatty acid side chains of cell and organelle membranes. The above mentioned lipid peroxidation can result in a serious damage of membrane structures and in the eventual death of the cell.

It is not surprising that living organisms are equipped with many protection systems against free radicals. Under normal circumstances the reactive oxygen species formation is in a balance with the activity of antioxidants. We can distinguish:

- 1) **enzymatic systems** (e.g. superoxide dismutase, catalase, glutathione peroxidase)
 - involved in radical destruction or repair of peroxidated structures
- 2) **low molecular weight antioxidants** (also known as 'free radical scavengers')

A free radical scavenger is a molecule that reacts with a high energy free radical species in a propagation step of a chain reaction, forming a more stable radical species which can be eliminated in some way before further damage is done to biomolecules. The principal ones present in humans are α -tocopherols (vitamin E), L-ascorbate (vitamin C), retinoids (vitamin A), ubiquinone, and many others.